

USER MANUAL



Hyper 3~6kW

Copyright Declaration

The copyright of this manual belongs to Hangzhou Livoltek Power Co.,Ltd.. Any corporation or individual should not plagiarize, partially or fully copy and no reproduction or distribution of it in any form or by any means. All rights reserved.

Contents

1.	About This Manual.....	1
	1.1 Scope of Validity.....	1
	1.2 Target Group	1
	1.3 Symbol Definition	1
2.	Safety Precaution.....	2
	2.1 Personnel Requirements	2
	2.2 Inverter Safety.....	2
	2.3 Battery Safety.....	3
	2.4 Installation Safety	3
	2.5 Electrical Safety	3
	2.6 Maintenance and Replacement.....	4
	2.7 PE Connection and Leakage Current	4
	2.8 EU Declaration of Conformity	5
3.	Product Introduction.....	6
	3.1 Product Description.....	6
	3.2 Application Scenarios	6
	3.3 Power Derating	7
	3.4 Declaration for Back-Up Function.....	7
	3.5 System Architecture.....	8
	3.6 Appearance and Dimension.....	9
	3.7 Terminal Description.....	10
	3.8 Work Modes.....	11
4.	Unpacking and Storage.....	14
	4.1 Packing List.....	14
	4.2 Identification Label.....	16
	4.3 Storage of Inverter	18
5.	Installation.....	19
	5.1 Installation Requirements.....	19
	5.2 Mounting Instruction.....	21

6.	Electrical Connection.....	28
6.1	Wiring Diagram.....	29
6.2	External Grounding (PE Cable) Connection	30
6.3	Grid Port Connection.....	31
6.4	EPS Output Connection.....	33
6.5	PV Connection.....	34
6.6	Battery Connection.....	36
6.7	WIFI Connection.....	42
6.8	DRM Connection	43
6.9	Multi COM Terminal Connection	44
7.	System Operation	49
7.1	LED Display.....	49
7.2	Start-up Procedures.....	51
7.3	Shut down Procedures	52
8.	APP Operation.....	53
8.1	User interface on the APP.....	53
8.2	Wi-Fi Configuration.....	54
8.3	Register an account.....	55
8.4	Create a site and add the inverter to the site.....	55
8.5	Setting on the APP.....	57
9.	Troubleshooting and Maintenance	61
9.1	Troubleshooting.....	61
9.2	Routine Maintenance.....	64
9.3	Decommissioning.....	64
9.4	Disposal of the Inverter.....	64
10.	Technical Data	65
11.	Disclaimer.....	68

1. About This Manual

Thank you for choosing our low-voltage hybrid inverter. This manual will assist you in becoming familiar with this product. Please keep this manual available at any time. And read the manual and other related documents before performing any operation on the inverter and take into account the connection requirements by your local grid utility. This manual cannot include complete information about the photovoltaic (PV) system. All descriptions in the manual are for guidance only.

1.1 Scope of Validity

This manual describes the installation process, maintenance, technical data and safety instructions for the following models:

Hyper 3000, Hyper 3680, Hyper 4600, Hyper 5000, Hyper 6000

“Hyper” means Hyper Series inverter





“3000” means the rated power is 3000W

1.2 Target Group

This manual is intended for qualified persons and inverter owners. All activities described in the document may only be carried out by specially trained personnel in compliance with standards, wiring rules and the requirements of local grid authorities or companies. Moreover, they must also understand basic safety precautions and with the knowledge of how to deal with the dangers and risks associated with installing, repairing and using electrical devices and batteries.

1.3 Symbol Definition

Safety instructions will be highlighted with the following symbols.

Symbol	Description
 DANGER	Indicates a hazard with a high level of risk that, if not avoided, will result in death or serious injury.
 WARNING	Indicates a hazard with a medium level of risk that, if not avoided, could result in death or serious injury.
 CAUTION	Indicates a hazard with a low level of risk that, if not avoided, could result in minor or moderate injury.
 NOTICE	Indicates a situation that, if not avoided, could result in equipment or property damage.

Note: This user manual is subject to change (specific please in kind prevail) without prior notice. For more product details and latest documents, visit <https://livoltek.com>.



2. Safety Precaution

- The inverter has been designed and tested strictly in accordance with international safety regulations. As with all electronic equipment, there are residual risks despite careful construction.
- Read all safety instructions carefully prior to any work and observe them at all times when working on or with the inverter to prevent personal injury and property damage and to ensure long-term operation of the inverter.
- Ensure that the equipment is used in environments that meet its design specifications. Otherwise, the equipment may become faulty, and the resulting equipment malfunction, component damage, personal injuries, or property damage are not covered under the warranty.
- Follow local laws and regulations when installing, operating, or maintaining the equipment. The safety instructions in this document are only supplements to local laws and regulations.

2.1 Personnel Requirements

- The inverter must be installed, electrically connected, operated and maintained by specially trained and qualified electrician.
- The qualified persons who plan to install or maintain LIVOLTEK equipment must receive thorough training, understand all necessary safety precautions, and be able to correctly perform all operations.

2.2 Inverter Safety

 DANGER
Danger to life due to electric shock when live components are touched on opening the product. <ul style="list-style-type: none">• High voltages are present in the live parts and cables inside the product during operation. Touching live parts and cables results in death or lethal injuries due to electric shock.• Do not open the inverter cover or change any components without manufacturer's authorization. Otherwise, the warranty for the inverter will be invalid.
 WARNING
Danger to life due to fire or explosion. <ul style="list-style-type: none">• In rare cases, an explosive gas mixture can be generated inside the product under fault conditions. In this state, switching operations can cause a fire inside the product or explosion. Death or lethal injuries due to hot or flying debris can result.• In the event of a fault, do not perform any direct actions on the product.• Ensure that unauthorized persons have no access to the product.• Only perform work on the product when wearing personal protective equipment for handling of hazardous substances.• Wait at least 10 minutes for the internal capacitors to discharge after the battery is powered off.• Ensure that there is no voltage or current before installing or disconnecting any connectors.• All safety instructions, warning labels, and nameplate on the inverter should not

be removed or covered.

 **CAUTION**

Risk of burns due to hot components! Avoid any unnecessary touching!

- Do not touch any hot parts (such as the heat sink) during operation. Only the DC switch can safely be touched at any time.

2.3 Battery Safety

 **DANGER**

Danger to life from electric shock due to live DC cables at the battery.

The DC cables connected to a battery may be live. Touching the DC conductors or the live components leads to lethal electric shocks.

- Do not touch non-insulated cable ends.
- Do not touch any live components.
- Observe all safety information of the battery manufacturer.
- Prior to performing any work on the inverter or the battery, disconnect the inverter from all voltage sources as described in this document.
- If an error occurs, have it rectified by qualified persons only.

 **WARNING**

Risk of burns due to electric arcs.

- Short-circuit currents in the battery can cause heat build-up and electric arcs.
- Disconnect the battery from all voltages sources prior to performing any work on the battery.

2.4 Installation Safety

NOTICE

- As soon as receiving the inverter please check if it is damaged during its transportation. If yes, please contact your dealer immediately.
- Adequate ventilation must be provided for inverter installation location.
- Mount the inverter in vertical direction, and ensure that no objects block the heat dissipation.
- The safety instructions in this manual cannot cover all the precautions that should be followed. Perform operations considering actual onsite conditions.
- LIVOLTEK shall not be held liable for any damage caused by violation of the safety instructions in this manual.

2.5 Electrical Safety

 **DANGER**

- Before installing the inverter check all electrical ports to ensure no damage and no short circuit, otherwise personal casualty and or fire will occur.
- Input terminals of the PV inverter apply only to input terminals of PV String do not connect any other DC source to the input terminals.
- Before connecting PV Arrays ensure that its voltage is within the safe range.

- Before touching the DC cables, operator must use a measuring device to ensure that the cable is voltage-free.
- The operator must follow all warnings on the PV strings and in its manual.
- All electrical connections must be in accordance with local and national standards. Only with the permission of the local utility grid company, the inverter can be connected to the utility grid.

2.6 Maintenance and Replacement

DANGER

- High voltage generated by the equipment during operation may cause an electric shock, which could result in death, serious injury, or serious property damage. Prior to maintenance, power off the equipment and strictly comply with the safety precautions in this document and relevant documents.
- Maintain the equipment with sufficient knowledge of this document and using proper tools and testing equipment.
- Before maintaining the equipment, power it off and follow the instructions on the delayed discharge label to ensure that the equipment is powered off.
- Turn off the AC and DC switches of the inverter when maintaining the electric equipment or power distribution equipment connected the inverter.
- For personal safety maintenance personnel must wear appropriate personal protective equipment (like insulation gloves and protective shoes) for the inverter maintenance.
- Place temporary warning signs or erect fences to prevent unauthorized access to the maintenance site.
- Follow the procedures of maintenance stipulated in the manual strictly.
- Check the relevant safety and performance of the inverter rectify any faults that may compromise the inverter security performance before restarting the inverter.
- To avoid any other unforeseeable risk, contact immediately your dealer, if there is any issue found during operation.
- The equipment can be powered on only after all faults are rectified. Failing to do so may escalate faults or damage the equipment.

2.7 PE Connection and Leakage Current

- All inverter is incorporate a certified internal Residual Current Monitoring (RCM) in order to protect against possible electrocution and fire hazard in case of a malfunction in the PV array, cables or inverter.
- There are 2 trip thresholds for the REMA as required for certification (IEC 62109-2:2011). The default value for electrocution protection is 30mA, and for slow rising current is 300mA.
- The inverter, with built-in RCM, will exclude possibility of DC residual current to 6mA, thus in the system an external RCD (type A) can be used ($\geq 30\text{mA}$).

WARNING

- High leakage Current!
- Earth connection essential before connecting supply.

- A faulty ground connection can result in equipment failure, personal and death injuries, and electromagnetic interference.
- Ensure correct according to grounding to IEC62109 and conductor diameter according to STANDARD specification.
- Do not connect the grounding end of the equipment in series to prevent multi-point grounding.
- Electrical appliances must be installed in accordance with the wiring rules of each country.

For United Kingdom

- The installation that connects the equipment to the supply terminals shall comply with the requirements of BS 7671.
- Electrical installation of PV system shall comply with requirements of BS 7671 and IEC 60364-7-712.
- All protective devices cannot be changed.
- User shall ensure that equipment is so installed, designed and operated to maintain at all times compliance with the requirements of ESQCR22(1)(a)

2.8 EU Declaration of Conformity

Hangzhou Livoltek Power Co., Ltd. hereby declares that the inverter with wireless communication module sold in the European market meets the requirements of the following directives:

- Radio Equipment Directive 2014/53/EU (RED)
- Restrictions of Hazardous Substances Directive 2011/65/EU and (EU) 2015/863 (RoHS).
- Waste Electrical and Electronic Equipment 2012/19/EU
- Registration, Evaluation, Authorization and Restriction of Chemicals (EC) No 1907/2006 (REACH).
- You can download the EU Declaration of Conformity on <https://livoltek.com>.

3. Product Introduction

3.1 Product Description

- The inverter is a single-phase hybrid inverter applicable to both on-grid and off-grid solar system with participation of PV array, battery, loads and grid system for energy management.
- The inverter converts the DC power from the PV array or the battery to the AC power, in conformity with the grid requirements. It also transmits the DC power from the PV panel to the battery. With the bidirectional converter integrated inside, the inverter can charge or discharge the battery.
- Several protective functions are integrated in the inverter, including short circuit protection, grounding insulation resistance surveillance, residual current protection, anti-islanding protection, overvoltage and over-current protection, etc.

3.2 Application Scenarios

- PV system is not suitable to connect equipment that relies on a stable power supply, such as: medical equipment to sustain life. Ensure that no personal injury is occurred when the system is disconnected.
- The BACK-UP function is not recommended if the PV system is not configured with batteries. Otherwise, the risk in system power usage is beyond the equipment manufacturer's warranty scope.
- Due to the condition of the battery itself, battery current might be limited by some factors, including but not limited to the temperature and weather.
- Please avoid the following installations which will damage the system or the Inverter. Any damage caused will not be covered by the warranty policy.
 - ① Only certain models support parallel connection. For details, please refer to the parallel operation instructions.
 - ② Single PV string cannot be connected to multiple inverters.
 - ③ One battery bank cannot be connected to multiple inverters.
 - ④ The EPS (backup) side cannot be connected to the grid.
 - ⑤ The inverter cannot be connected to any AC generator directly.
 - ⑥ The inverter cannot be connected to any incompatible batteries.

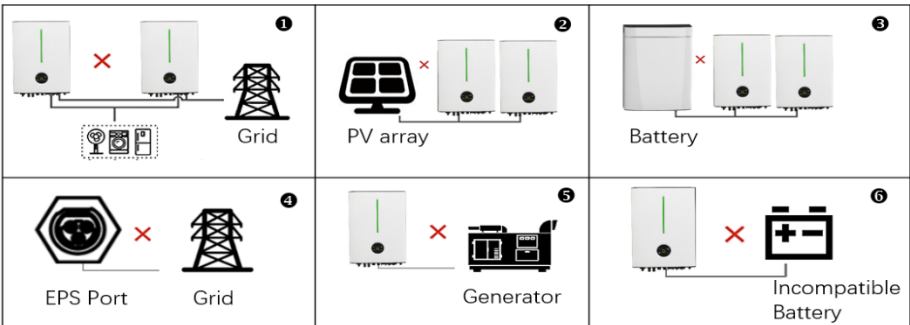

3.3 Power Derating

- Power derating is a way to protect the inverter from overload or potential faults. For a safe operation, the inverter will automatically reduce the output power when the operating environment is not ideal. The following are the factors that may occur power derating. Please try to avoid them during usage.
 - ✧ Unfavorable environmental conditions, e.g., direct sunlight, high temperature, etc.
 - ✧ Over-temperature (including ambient temperature and module temperature).
 - ✧ Power factor (when values out of the rated values)
 - ✧ Over-frequency derating.
 - ✧ Higher input voltage value.
 - ✧ Higher input current value.

3.4 Declaration for Back-Up Function

- The BACK-UP function can provide to the normal household load when the grid is disconnected. To ensure the stability of switching time and load power supply, avoid using loads with higher starting current, such as air conditioner, high-power pump, vacuum cleaner, and hair drier.
- The inverter has the overload protection capability. When single overload protection occurs, the inverter can restart automatically; however, the restarting time will be extended if it happens several times. For a faster restarting, try to turn off the large loads and ensure the load power is within maximum limitation or remove the loads which may cause very high start-up current surges.

NOTICE
<ul style="list-style-type: none">• Appliances such as air conditioner are required at least 2~3 minutes to restart because it's required to have enough time to balance refrigerant gas inside of circuits. If a power shortage occurs and recovers in a short time, it will cause damage to your connected appliances.• To prevent this kind of damage, please check manufacturer of air conditioner if it's equipped with time-delay function before installation. Otherwise, this inverter will trig overload fault and cut off output to protect your appliance but sometimes it still causes internal damage to the air conditioner.

3.5 System Architecture

The following figure shows inverter application in a PV energy storage system.

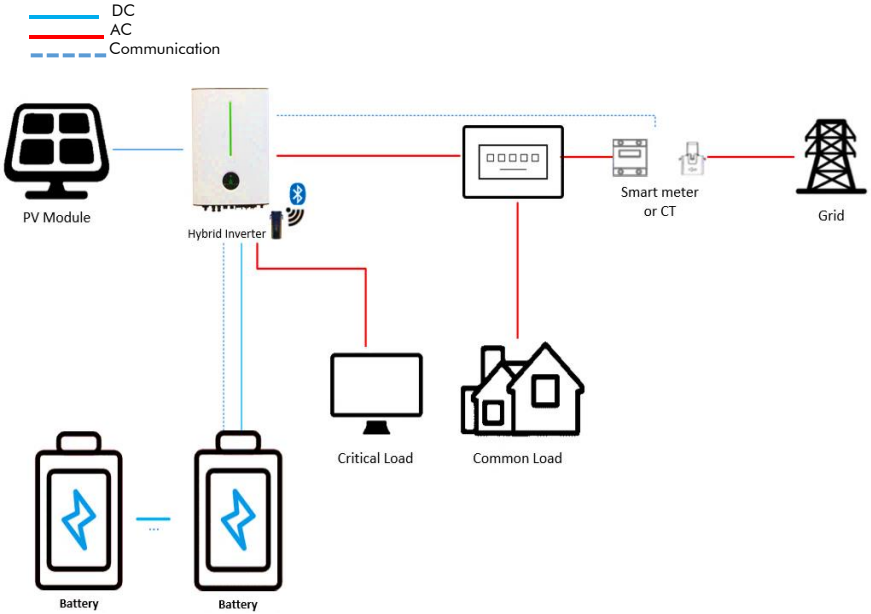

Description	Note
PV Module	PV string is composed of series connected PV panels.
Critical Load	Protected house loads, connected to inverter EPS (backup) port, which need uninterrupted power supply.
Common load	Normal household loads, which will be lack of power when grid is blackout.
Smart meter or CT	The CT (Current Transformer) is default delivered with the inverter, the smart meter needs to be purchased from the inverter manufacturer.
Grid	Utility grid, supported Grid Types: TT, TN-C, TN-S, TN-C-S. For the grid structure with N cable, the effective value of the voltage between the neutral wire and the ground wire must be less than 10V. When the inverter is used in TT and IT systems, it is required that the inverter casing must be grounded, and the default ground fault detection function can be turned off through the APP.
Battery	Select the battery model according to the approved battery list.

3.6 Appearance and Dimension

The following figure shows the dimensions of the inverter. The image shown here is for reference only. The actual product received may differ.

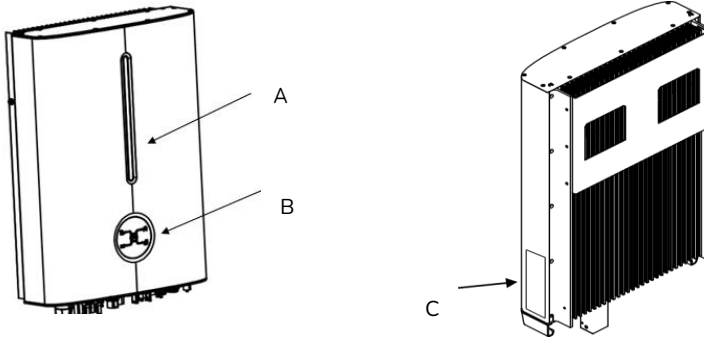

Figure 1. Appearance

Position	Designation
A	Battery SOC indicator: Indicates the SOC of the connected battery.
B	Inverter LED indicator: Displays the current working state of the inverter.
C	Nameplate Label: To clearly identify the product, including device model, S/N (series number), technical data, certifications, etc.,

The following figure shows the dimensions of the inverter.

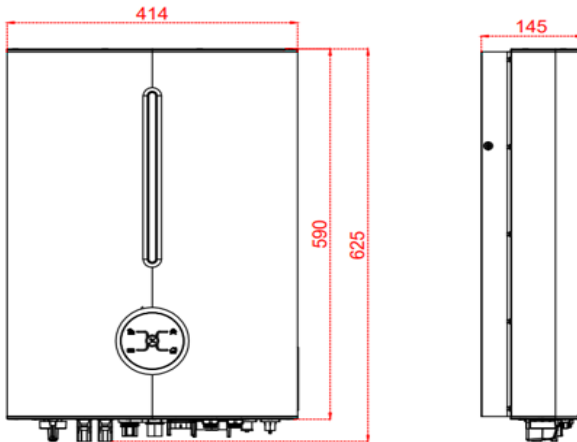

Figure 2. Dimension

3.7 Terminal Description

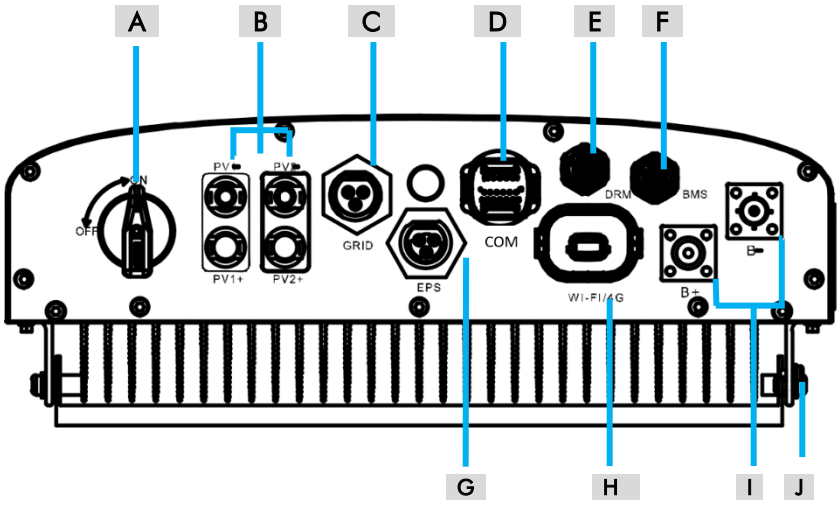

Figure 3. Terminals on the inverter

Position	Description
A	DC Switch
B	PV Input Terminal (The terminal number depends on inverter model)
C	Grid Terminal for connection to the utility grid
D	Multi COM(Communication) Terminal for CT, EV charger, Dry and meter
E	DRM Terminal block for connecting to a demand response enabling device (DRED).
F	BMS Communication Port for communication between the inverter and the Li-Ion battery.
G	AC Terminal for backup loads
H	Communication Port for Wi-Fi Stick
I	Battery Input Terminal (BAT+/BAT-)
J	Additional grounding terminal

Note: The image shown here is for reference only. The actual product received may differ.

3.8 Work Modes

The hybrid inverter offers four operating modes (Self-use, Self-define, backup and off-grid) based on different requirements. Which can be configured via LIVOLTEK APP for you to determine which mode will be best for you.

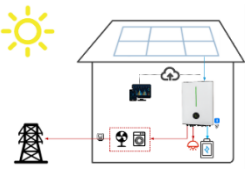
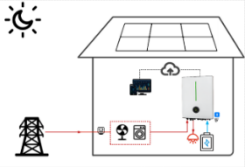
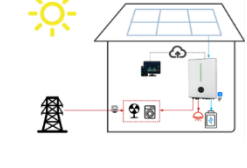
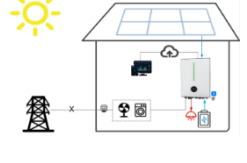
Work Modes	Description
<p style="text-align: center;">Self-Use</p> 	<p>The self-use mode is suitable for areas with the low import rate and high electricity price. The purpose of this mode is to maximize the solar energy usage and lower the power import from the grid.</p> <ul style="list-style-type: none"> • When the power of PV is sufficient, the power generated from PV will be used to supply the loads first, the excess energy is used to recharge the batteries, any remaining excess is then exported to the grid (if allowed) . • When PV energy is insufficient or without PV power, the battery bank will discharge to support critical loads. And when the battery is insufficient, the grid will power the loads.
<p style="text-align: center;">Self-Define</p> 	<p>The self-define mode is suitable for areas with time of use tariffs which means prices vary between peak and valley.</p> <ul style="list-style-type: none"> • The purpose of this mode is to help the customer using the solar energy at times that best suit them to reduce influence of power price hikes and reduce energy costs. • During the set time period, it will charge or discharge the battery using timed schedules. And during the non-set time period, it will work in self-use mode.
<p style="text-align: center;">Backup Mode</p> 	<p>The Backup mode is suitable for areas with unstable grid to prolong the autonomy in the event of grid outage. Or reducing the frequency charging and discharging of battery to extend battery life.</p> <ul style="list-style-type: none"> • This work mode will ensure the battery reserves a minimum capacity fully charged (can be set via APP) for when there is a grid outage. • The battery will never discharge when the capacity is lower than the set value when the grid is on.
<p style="text-align: center;">Off-grid Mode</p> 	<p>The Off-grid mode is suitable for non-grid areas, and the inverter will automatic activation this mode in the event of grid failure.</p> <ul style="list-style-type: none"> • When the grid fails, the system will automatically switch to this mode. The critical loads will be powered by PV production and Battery. • Battery is necessary in this mode, and EPS loads shall not exceed the max. output power of batteries.)

Note: Contact us for additional or more complex application requirements.

3.8.1 On-Grid Self-Use Mode

The on grid self-use operating mode is recommended for when the system is installed in an area with a stable grid. The purpose is to increase self-consumption of PV energy and save electricity costs. When Inverter is set to work in this mode:

- **During daytime and there is sufficient PV Power,**
 - ◇ The PV energy is used to supply local loads as first priority and then charge the battery, any excess energy will be fed into grid *1.
 - ◇ When battery is fully charged, PV energy is supplied to the local loads and fed into grid*1.
- **During nighttime or there is not sufficient PV Power,**
 - ◇ Battery is discharged to supply local loads until reaches its power limit*2, if extra power is required, it will be imported from grid.
 - ◇ The battery will stop to discharge when the value is lower than the discharge cut-off value, which is available for setting, the local loads will be supplied from the grid.
 - ◇ The switch from battery power, PV power and grid power is automatic and seamless.
- **When grid fails,**

In the event of a grid failure or there's no mains, the hybrid inverter automatically switches to Off-grid operation mode. The off-grid mode ensures that the system forms a battery-backup grid that utilize power from PV production and battery to supply power to critical loads.

NOTICE
*1: The inverter can be set not to feed power into the grid. But a small amount of energy will still inevitably be fed into grid due to unpredictable PV power changes and load fluctuations. *2: The battery power supply can be restored when the battery is charged to the "set value +10%" by solar.

3.8.2 On-Grid Self-Define Mode

When operating in this mode, the charging and discharging time can be set flexibly as required. This mode is ideal for those who want to store the power in the battery when the electricity price is at an off-peak rate and use the power during peak rate time or save the energy for grid outages.

- ◇ During charge time, solar energy and grid will charge the battery bank as first priority at the same time, any excess PV energy will supply local loads and then be fed into the grid*1.
- ◇ During discharge time, PV power will supply local loads first, then excess PV power and battery power will be fed into grid*1.
- ◇ The inverter will automatically work in Self-Use mode outside the set time of Charge or Discharge.

NOTICE
*1: The inverter can be set not to feed power into the grid. But a small amount of energy will still inevitably be fed into grid due to unpredictable PV power changes and load fluctuations. *2: The battery power supply can be restored when the battery is charged to the "set value +10%" by solar.

3.8.3 On-Grid Backup Mode

Keep the battery at a high level (default 50%, which is available for setting) for areas with unstable grid that need a large amount of battery to support the emergency use in the event of grid outage. Or reducing the frequency charging & discharging of battery to extend battery life.

- ✧ When there is grid connected, the battery is only allowed to discharge when its capacity is above the set value.
- ✧ When the capacity of the battery power is less than the set value, the solar energy and grid will charge battery to the set value as first priority. If the PV energy is sufficient, it will fully charge the battery and the excess power will be fed to the grid*1.
- ✧ The loads will be supplied by the surplus solar production supplemented, if necessary, by the public electricity grid.

NOTICE
*1: The inverter can be set not to feed power into the grid. But a small amount of energy will still inevitably be fed into grid due to unpredictable PV power changes and load fluctuations. *2: The battery power supply can be restored when the battery is charged to the “set value +10%” by solar.

3.8.4 Off-Grid Mode

When operating in this mode, Photovoltaic and battery constitute a pure off-grid system, the critical loads (EPS Loads) will be powered by PV production and if the PV production is insufficient, battery will discharge to power the loads at the same time. (Battery is necessary in this mode.)









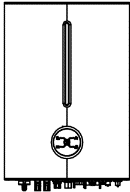
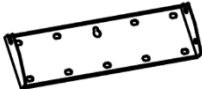

NOTICE
•When battery is discharged to the discharge cut-off value (@EPS), the inverter will stop working and wait for the grid to recover or until there is sufficient power from PV panels to charge the battery. •If grid failure is a common occurrence in your area, it is recommended to adjust the discharge cut-off value (@Grid) higher to ensure there is more battery power available.

4. Unpacking and Storage

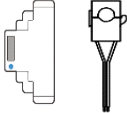
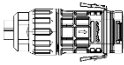
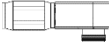
The inverter is thoroughly tested and strictly inspected before delivery. Damage may still occur during shipping. Please check the outer packing for damage and the inner contents for any visible damage. Contact your distributor immediately in case of any damaged or missing components.

4.1 Packing List

Check if all the accessories are in the package, the standard accessories are listed as below:

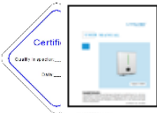
 <p>A</p>	 <p>B</p>	 <p>C</p>	 <p>D</p>
 <p>E</p>	 <p>F</p>	 <p>G</p>	 <p>H</p>
 <p>I</p>	 <p>J</p>	 <p>K</p>	 <p>L</p>
 <p>M</p>	 <p>N</p>	 <p>O</p>	 <p>P</p>

Position	QTY	Designation
A	1	Inverter
B	1	Inverter Bracket (for Split Application)
C	1	EPS Plug for backup loads (critical Loads)
D	1	AC Plug for Grid
E	2 or 4	Positive & Negative PV Plugs (One pair for 3kW, Two pairs for 3.68~6kW)
F	1	Wi-Fi & Bluetooth integrated Stick
G	1	CT (with cable) or Smart Meter optional
H	1	16pin Multi COM connector for CT/EV charger
I	2	Positive & Negative BAT Plugs (one pair)
J	4	Expansion bolts for Wall-mounting Bracket (for Split Application)
K	1	Screws for Fixing Mounting Bracket
L	1	PE terminal
M	1	Water-proof RJ45 Connector for BMS (for Li-Ion battery)
N	1	Water-proof RJ45 Connector for DRM port
O	1	NTC cable (Temperature sensor for Lead-acid battery) & PVC tape for NTC cable
P	3	Documents (User Manual & Quick Guide & Certificate)

Note: If anything is missing, please contact your local distributor.

4.2 Identification Label

4.2.1 Nameplate

After moving the hybrid inverter from package, identify it by reading its nameplate labeled on the side of the inverter. The nameplate contains important product information: the model information, technical specifications and compliance symbols.

LIVOLTEK

Hybrid Inverter
Model Name: Hyper-5000

Safety symbols: High Voltage, Low Voltage, Fire, Explosion, Shock, and others.

CE, UKCA, and other certification marks.

Max. PV Voltage	600V d.c.
MPPT Voltage Range	125-550V d.c.
Max. PV Current	14.714A d.c.
PV Isc	17.5/17.5A d.c.
PV Inverter Topology	Non-isolated
Rated AC Voltage	220/230V a.c.1 ☉
Rated AC Frequency	50/60Hz
Rated AC Power	5000VA
Max. Output Current	21.7A a.c.
Power Factor Range	-0.8~+0.8
Battery Type	Lithium
Rated Battery Voltage	48V d.c.
Battery Voltage Range	40-60V d.c.
Max. Charge Current	100A d.c.
Max. Discharge Current	100A d.c.
Galvanic Isolation for Bat.	Yes
AC Overvoltage-Category	III
DC Overvoltage-Category	II
IP Protection	IP65
Protective Class	Class I

Grid Regulations:
 G99; C10/11; AS/NZS 4777.2;
 C15-712-1; EN50548; NRS 097-2-1;
 IEC 61727; IEC 62116; RD 1699;

Blank box for serial number and contact information.

Hangzhou Livoltek Power Co., Ltd.
 Add: 1418-35, Moganshan Road,
 Hangzhou City, China
 web: www.livoltek.com











MADE IN CHINA
 L_Hyper5000_Livoltek1.2_04

DRM0 DRM1 DRM2 DRM3 DRM4 DRM5 DRM6 DRM7 DRMB
 ☒ ☒ ☒ ☒ ☒ ☒ ☒ ☒ ☒ ☒

Annotations:
 - Product type, and product model
 - Safety symbols and certification marks
 - Technical parameters
 - Serial number and contact information

Note: The nameplate shown here is for reference only. The actual product received may differ.

4.2.2 Compliance and Safety Symbols

Symbol	Explanation
	CE marking The product complies with the requirements of the applicable EU directives.
	UKCA marking The inverter complies with the requirements of the applicable UKCA guidelines.
	UKNI marking The inverter complies with the requirements of the applicable UKNI guidelines.
	Caution! Beware of a danger zone! Failure to observe any warnings contained in this manual may result in injury.
	Danger! Beware of hot surface! The inverter can become hot during operation.
	Danger! Beware of high voltage and electric shock! Beware of electrical voltage, the product operates at high voltages.
	Observe the documentation. Observe all documentation supplied with the product.
	WEEE designation. Do not dispose of the product together with the household waste but in accordance with the disposal regulations for electronic waste applicable at the installation site.
	RCM marking Regulatory compliance mark.
	Danger to life due to high voltage and electric shock! There are residual voltages in the inverter after powering off, you should wait at least 5mins after disconnecting the inverter from the utility grid and from the PV panel before touching any inner live parts.

Note: The table shown here is for reference only. The actual product received may differ.

4.3 Storage of Inverter

The following requirements should be met if the inverter will not be deployed immediately:

- Do not unpack the inverter (put desiccant in the original box if the inverter is unpacked).
- Store the inverter at a temperature range of -30°C to $+70^{\circ}\text{C}$, and with the relative humidity of 0% to 100% (no condensing).
- In case of stacking storage, the number of stacking layers should never exceed the limit marked on the outer side of the packing case.
- The inverter should be stored in a clean and dry place and be protected from dust and water vapor corrosion.
- Do not store the inverter in places susceptible to direct sunlight, rain, and strong electric field.
- Do not store the inverter in places with corrosive substances or susceptible to rodents and insects.
- Carry out periodic inspections. Inspection shall be conducted at least once every six months.
- If any insect or rodent bites are found, replace the packaging materials in time.
- If the inverter has been stored for more than a year, inspection and testing by professionals are required before it can be put into operation.
- If the inverter needs to be transported again, pack it strictly before transporting it.

NOTICE
<ul style="list-style-type: none">• Please store the inverter according to the storage requirements. Product damage caused by failure to meet the storage requirements is not covered by the warranty.

5. Installation

5.1 Installation Requirements

NOTICE	
<ul style="list-style-type: none">• Make sure there is no electrical connection before installation.• In order to avoid electric shock or other injury, make sure that holes will not be drilled over any electricity or plumbing installations.• Always follow the instructions when moving or positioning the inverter.• Improper operation may cause injuries or serious wounds. In the case of poor ventilation, the system performance may compromise.	

5.1.1 Location Requirements

Select an optimal mounting location for safe operation, long service life and expected performance.

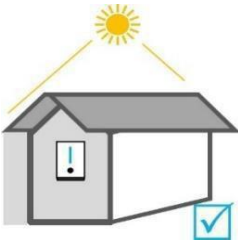

No direct sunlight



No rain exposure



No snow lay up

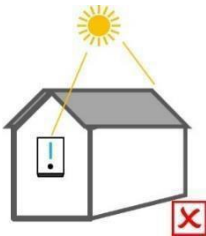

Direct sunlight



Rain exposure



Snow lay up

Note:

-
- **AVOIDE** direct sunlight, rain exposure, snow laying up during installation and operation.
- **DO NOT** install the inverter in a place where personnel are likely to come into contact with its enclosure and heat sinks because these parts are extremely hot during operation.

5.1.2 Environment Requirements

The inverter must be installed in a ventilated environment to ensure good heat dissipation. Make sure the installation meets the following conditions:

- Not in areas where highly flammable materials are stored.
- Not in potential explosive areas.
- Not in the cool air directly.
- Not near the television antenna or antenna cable.
- Not higher than altitude of about 2000m above sea level.
- Not in environment of precipitation or humidity (>95%).
- The slope of the wall should be within $\pm 5^\circ$.
- The wall must be solid enough to bear the weight of the inverter.
- Do not install the inverter on a wall made of gypsum boards or similar materials with weak sound insulation to avoid noise disturbance in a residential area.

5.1.3 Angle and Space Requirements

NOTICE

- Never install the inverter horizontally, or with a forward tilt or with a backward tilt or even with upside down. The horizontal installation can result in damage to the inverter.
- Install the inverter upright or at a maximum back tilt of 15 degrees to facilitate heat dissipation.

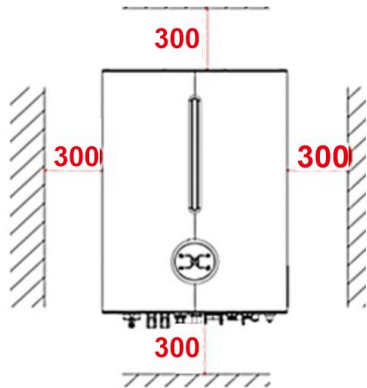
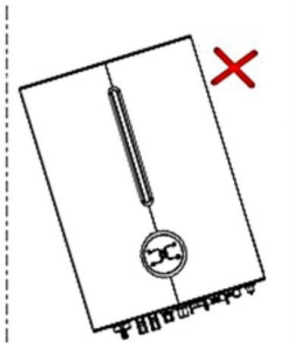
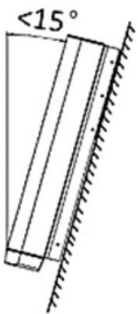

5.1.4 Tools Preparation

Installation tools recommended but not limited to the following ones. If necessary, use other auxiliary tools on site.

 <p>Bit $\phi 10$ Hammer drill</p>	 <p>Rubber hammer</p>	 <p>Tape ruler</p>	 <p>Spirit level/Marker</p>
 <p>Protective glasses</p>	 <p>Dustproof Cover</p>	 <p>OT terminals press clamp</p>	 <p>Wire stripper</p>
 <p>DC Voltage (Range $\geq 1100V$ DC) Multimeter</p>	 <p>Euro terminal crimping tool</p>	 <p>Diagonal pliers</p>	 <p>Multifunction terminal crimping tool (RJ45)</p>

5.2 Mounting Instruction

Two installation methods:

- There are two ways for hybrid inverter to be installed with the battery. One called "Split Application" and the other called "All-in-one Application".
- For Split Application, the inverter can be connected with low voltage Li-Ion battery or Lead-acid battery.
- For All-in-one Application, the inverter must be connected with the Li-Ion battery of LIVOLTEK brand. And there are three independent packages (inverter, battery and middle cover kit) for the installation. Please check and contact your distributor immediately in case of any damaged or missing components.

5.2.1 Mounting the Inverter (Split Application)

Step1: Drill holes on the wall

- Take out the wall-mounting Bracket from the inverter package.
- Locate the appropriate drilling holes and mark it with a marker pen (Using a digital level to make sure the bracket is at a horizontal position before installation.)
- Drill holes with driller, make sure the holes are deep enough (at least 70mm) to support the inverter.

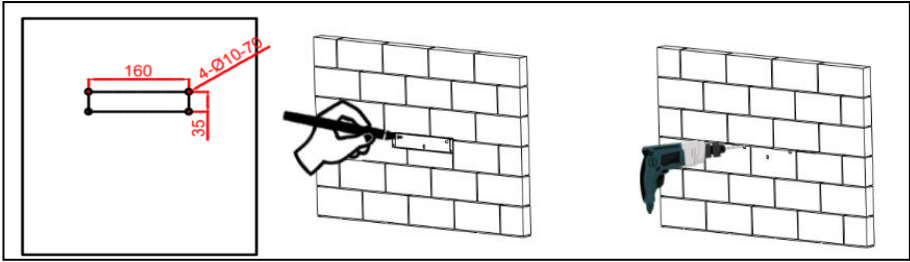

NOTICE

- The inverter must not be installed near flammable or explosive materials or near the equipment with strong electromagnetism.
- The inverter is suitable for mounting on concrete or other non-combustible surfaces only.
- The bearing capacity of the wall must be greater than 35kg. Otherwise, the wall may not be able to prevent the inverter from dropping.

Step 2: Secure the mounting bracket on the wall

- Use expansion bolts or correct wall fixings to attach the mounting bracket to the wall tightly.

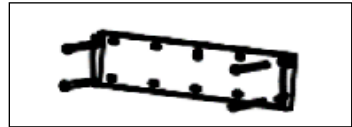

Step 3: Mount the inverter to the mounting bracket

- Carry the inverter by holding the heat sink on two sides and hang the inverter on the mounting bracket. And then lock the side with screw.

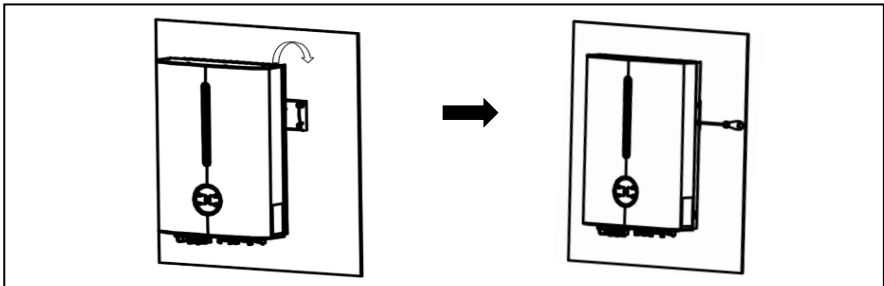

Step 4: Installation Self-check

- Ensure the inverter is well fixed;
- Ensure DC-switch is switched to OFF.

5.2.2 Mounting the All-in-one System

Step1: Choose a location

- Choose an appropriate location capable

of supporting the full weight (>90kg) and height of All-in-one system.

Note:

- It is recommended to install the inverter in a suitable location which offers easy and safe access for service and maintenance.
- Do not install the unit near or on flammable surfaces.
- Mount the unit tightly on a solid/smooth surface.

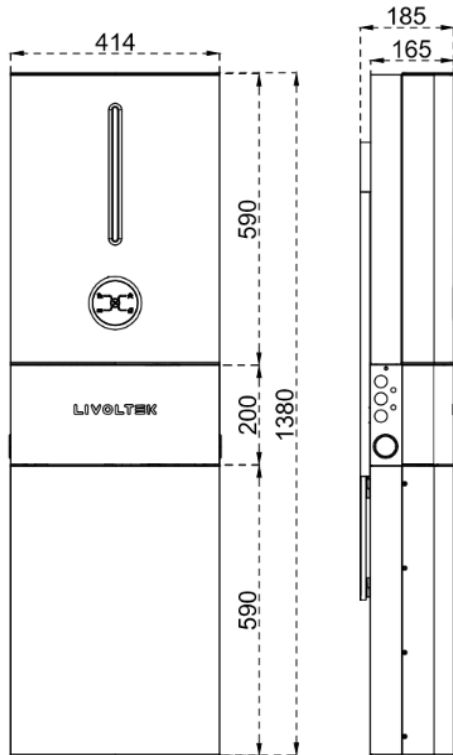

Step 2: Take out the Brackets

- Open the packages of battery and middle cover kit respectively, then take out the wall-mounting brackets.

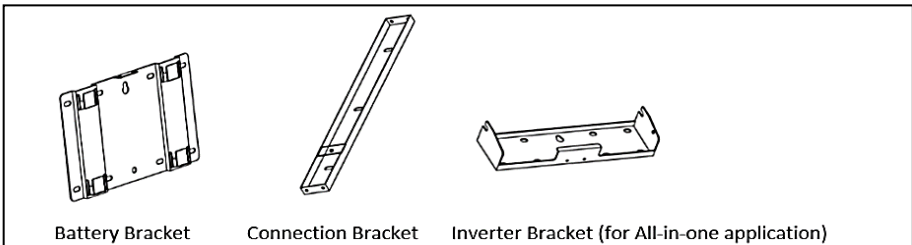

Note: The inverter-bracket for all-in-one application is not as same as the split one, please leave the split bracket and expansion bolts in the inverter's package when you want to install the all-in-one system).

Step 3: Assemble the All-in-one Mounting Bracket

- Assemble the All-in-one Mounting Bracket with 4 screws as shown below.

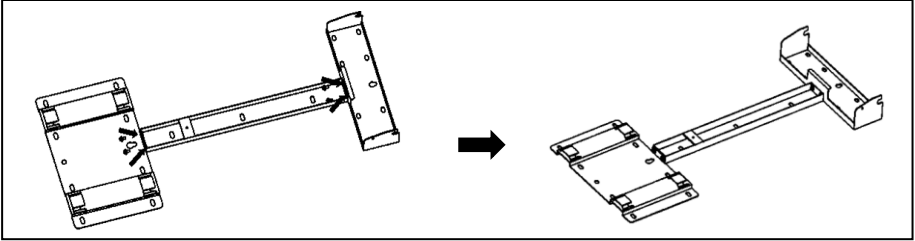

Step 4: Anchor All-in-one Mounting Bracket

- Determine the positions for drilling holes using the marking-off template, and then mark the positions with a marker.
- The height of the holes from the ground should be $\geq 450\text{mm}$
- Drill holes with driller, make sure the holes are deep enough.

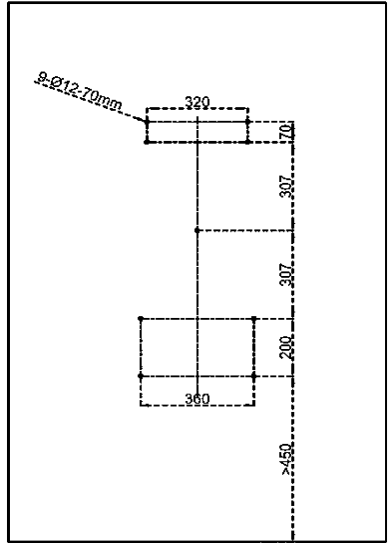

Step 5: Secure the All-in-one bracket on the wall

- Fix the All-in-one bracket to the wall with 9 expansion bolts.

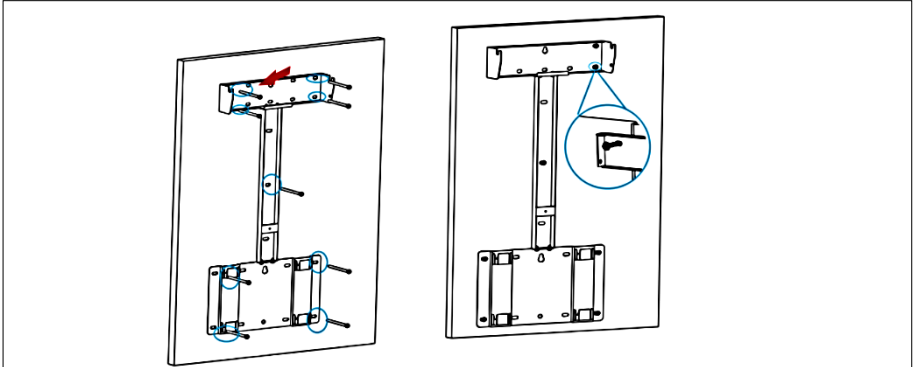

Step 6: Remove the upper cover of the Battery if needed

- Pull out the front cover of the wiring area, then loosen the screws on the top cover to remove the upper cover of the battery.

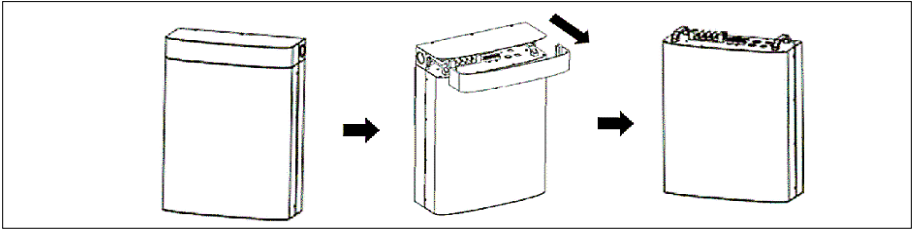

Step 7: Mount the battery on the Bracket

- Lift and hang the battery to the battery-bracket.

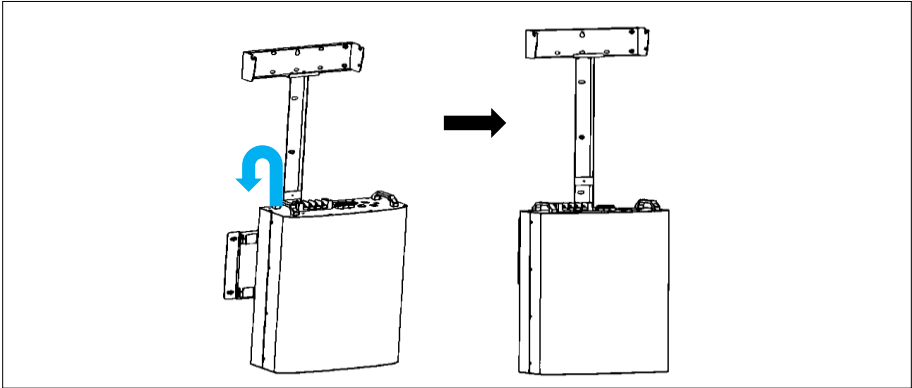

Step 8: Install the bottom of middle cover kit to the Bracket

- Install the bottom of middle cover kit to the all-in-one bracket and tighten the screws (M5*5).

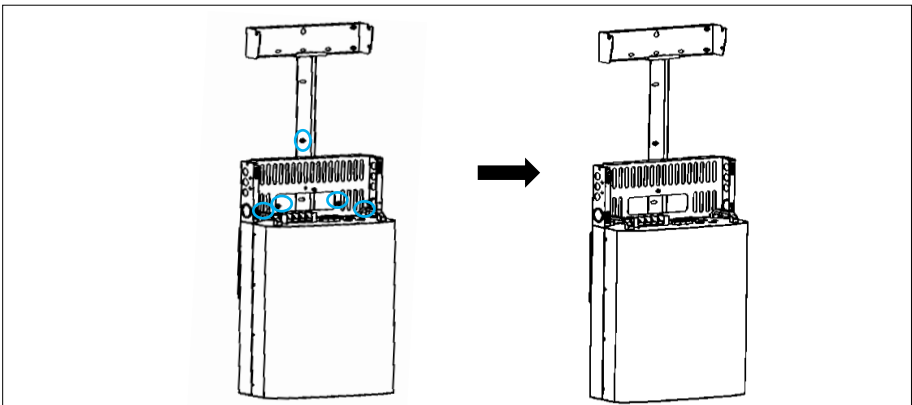

Step 9: Mount the Inverter to the Bracket

- Lift the inverter and slide it down along the wall-mounting bracket to make sure they match perfectly.
- Use two screw sets to lock both left and right sides.

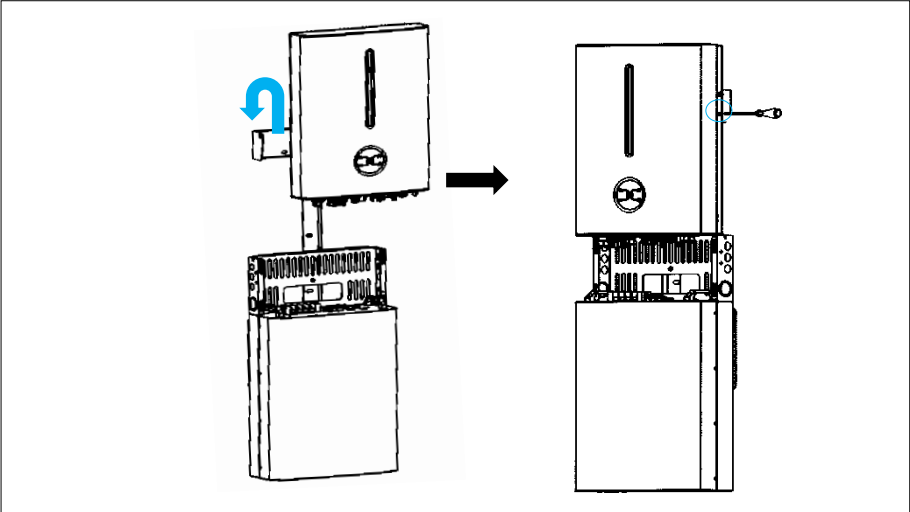

Step 10: Install the side frames

- Install the left and right frames. The upper part of which should be hung to the corresponding holes of the inverter, and the lower part should be inserted into the middle cover bottom. Then tighten them with M5 screws.

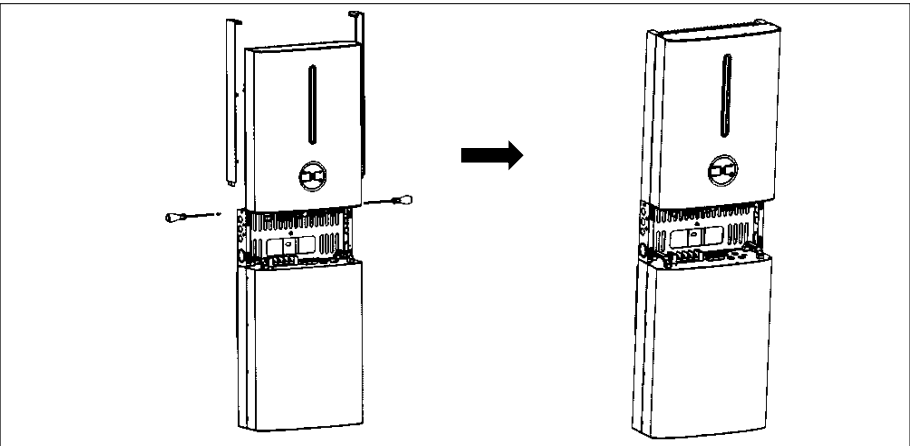

Step 11: Electrical Connection

Please refer to the Electrical Connection instructions in the next chapter.

Step 12: Install the Middle-cover

- Buckle the middle-cover to the all-in-one system after all electrical connection and settings are done
- DO NOT forget to grounding the Inverter and battery.

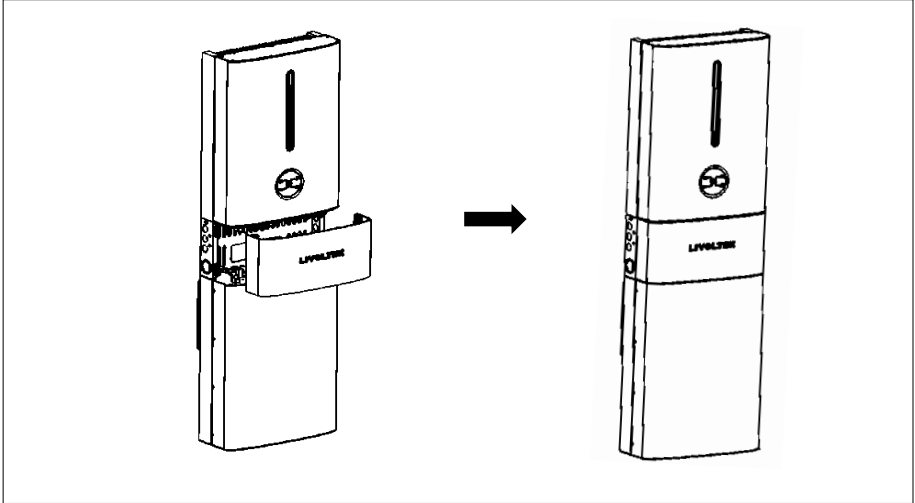

6. Electrical Connection

Prior to any electrical connections, keep in mind that the inverter has dual power supplies. It is mandatory for the qualified personnel to wear personal protective equipment (PPE) during the electrical work.



DANGER

Danger to life due to a high voltage inside the inverter!

- The PV strings will generate lethal high voltage when exposed to sunlight. Before starting electrical connections, disconnect the DC and AC circuit breakers and prevent them from inadvertent reconnection.
- All operations, cables and parts specification during the electrical connection shall be in compliance with local laws and regulations.
- Disconnect the DC switch and the AC output switch of the inverter to power off the inverter before any electrical connections. Do not work with power on. Otherwise, an electric shock may occur.



WARNING

- Any improper operations during cable connection can cause device damage or personal injury.
- Wear personal protective equipment like safety shoes, safety gloves, and insulating gloves during electrical connections.
- Only qualified personnel can perform cable connection.
- All cables must be firmly attached, undamaged, properly insulated and adequately dimensioned.

NOTICE

- Comply with the safety instructions related to the PV strings and the regulations related to the utility grid.
- All electrical connections must be in accordance with local and national standards.
- Only with the permission of the utility grid, the inverter can be connected to the utility grid.
- When the inverter is powered on, the EPS(BACK-UP) port is charged. Power off the inverter first if maintenance is required for the loads connected with EPS port. Otherwise, it may cause electric shock.

Note:

The cable colors shown in the electrical connection diagrams provided in this chapter are for reference only. Select cables in accordance with local cable specifications (green and yellow cables are only used for PE).

6.1 Wiring Diagram

Wiring diagram of Hybrid System

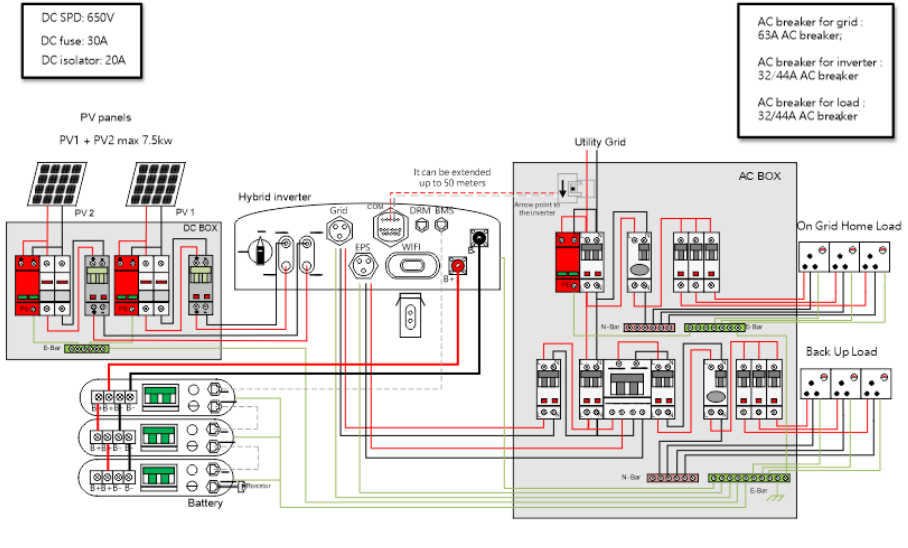

WARNING

- N and PE wiring via ON-GRID and BACK-UP ports of the inverter are different based on the regulation requirements of different regions. Refer to the specific requirements of local regulations.
- For Australia, New Zealand and South Africa, the neutral cable of GRID side and BACK-UP side must be connected together, otherwise EPS(BACK-UP) function will not work.
- In Australia and New Zealand, electrical installation and maintenance shall be conducted by a licensed electrician and shall comply with Australia/New Zealand National Wiring Rules. Because the inverter does not maintain neutral integrity, an external neutral connection must be used in Australia and New Zealand. 30mA Type "A" RCD can be used where required by AS/NZ_3000, but cannot be used if there are backup loads on the inverter as per AS4777.
- If the battery is integrated with a readily accessible internal DC breaker, no additional DC breaker is required.

6.2 External Grounding (PE Cable) Connection

6.2.1 External Grounding Requirements

Good grounding for the inverter helps resist the impact of surge voltage and improve the EMI performance. Connect the PGND cable before connecting the AC power cables, DC power cables, and communication cables.

⚠ WARNING
<ul style="list-style-type: none"> • Ensure that the PE cable is securely connected. Otherwise, electric shocks may occur. • Do not connect the neutral wire to the enclosure as a PE cable. Otherwise, electric shocks may occur.

NOTICE
<ul style="list-style-type: none"> • The PE point at the AC output port is used only as a PE equipotential point, and cannot substitute for the PE point on the enclosure. Make sure the two terminals are both grounded reliably. • It is recommended that silica gel or paint be used around the ground terminal after the PE cable is connected.

6.2.2 Wiring Connection Procedure

The PE cable should be prepared by customers. Recommended specifications:

- Type: Outdoor single-core copper wire.
- Conductor cross-sectional area: 4-6mm²

Step1: Crimping OT terminals

- Prepare the cable and remove an appropriate length of the insulation layer from it.
- Insert the exposed core wires into the crimping areas of the OT terminal and crimp them using hydraulic pliers.

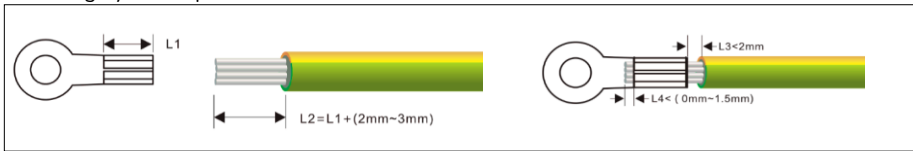

Step2: Connecting the PE Cable

- Remove the screw on the grounding terminal on the side of the inverter and fasten the cable with a screwdriver.
- Apply paint to the grounding terminal to ensure corrosion resistance.

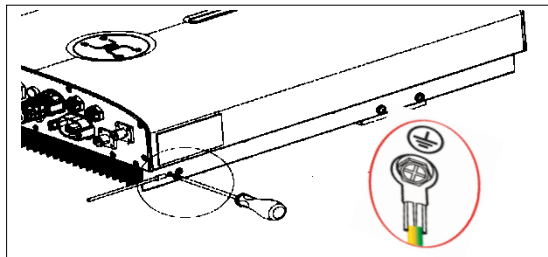

6.3 Grid Port Connection

The hybrid inverter has two AC output terminals, one is grid output for connecting grid and the other is EPS (emergency power supply) output for connecting critical (backup) Loads.

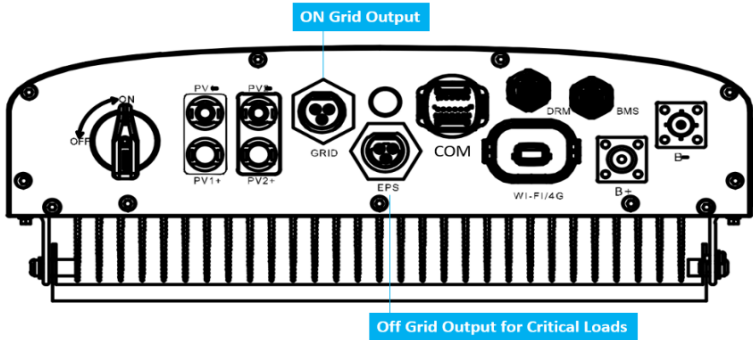

⚠ WARNING

- Make sure inverter is totally isolated from any DC or AC power before connecting AC cable.
- Only with the permission of the local grid department, the inverter can be connected to the grid.
- Before commencing AC wiring, please ensure all AC circuit breakers are switched off.
- **DO NOT** connect the AC grid terminal and AC Backup (EPS) terminal together.
- **DO NOT** connect the AC Backup (EPS) terminal to grid.
- When you want to use both on grid power and backup power, please connect both with Grid output and EPS output. When you want to use on grid only, please connect with Grid output and float EPS output.
- Determine whether an AC circuit breaker with greater overcurrent capacity is required based on actual conditions.
- The grid voltage and frequency must be in the permissible range.
- Never connect a load between the inverter and the circuit breaker.

6.3.1 Wiring Connection Procedure

The AC cable should be prepared by customers. And an external AC circuit breaker should be installed on the output side of the inverter and the grid side (between inverter and loads) to ensure safe disconnection from the grid. The recommended specifications are as follows.

Model	Wire Size	Cable	Beaker
3KVA	10-12AWG	4-6mm ²	230/25A
5KVA	10-12AWG	4-6mm ²	230/32A
6KVA	8-10AWG	6-8mm ²	230/44A

Step1: Assembling the Grid Connector

- Take out the AC terminal from the package box and uninstall it as below chart.
- Put the AC cables through the terminal cap, threaded sleeve in sequence.

- Remove the cable jackets and strip the wire insulation by 5~7 mm then insert cables into connection terminals according to polarities indicates on it and tighten the screws.
- Push threaded sleeve onto the connection terminal until both are locked tightly.
- Screw up the terminal cap.

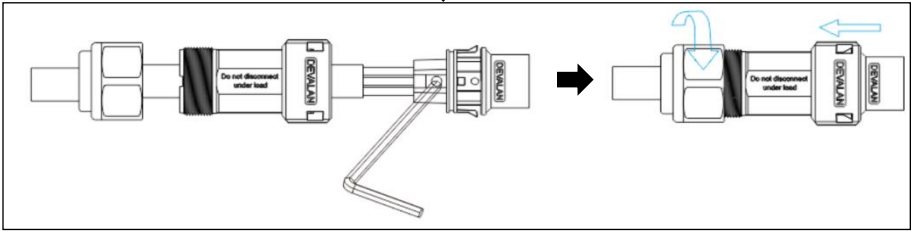
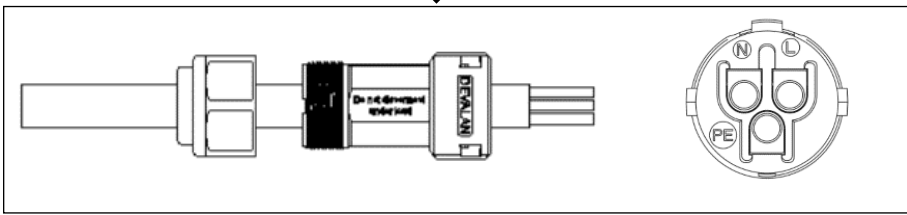
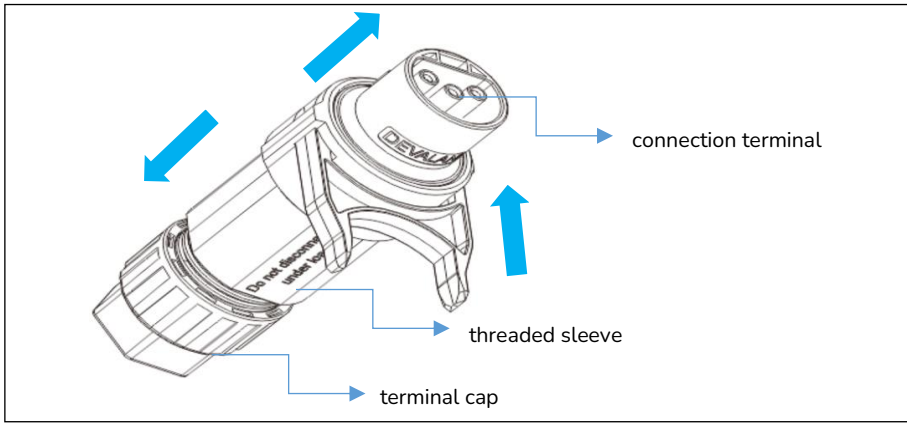

Step 2: Connecting the Grid terminal into the Grid Port on the inverter

- Unscrew the cap on the Grid port.
- Insert the Grid connector into the Grid port on the bottom of the inverter.
- Check all the wires are firmly installed.

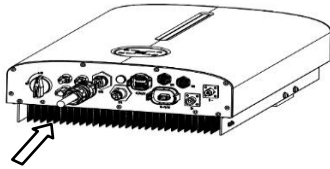

6.3.2 Residual Current Monitoring Device

With an integrated universal current-sensitive residual current monitoring unit included, the inverter will disconnect immediately from the mains power once a fault current with a value exceeding the limit is detected. However, if an external residual current device (RCD) (type A is recommended) is mandatory, the switch must be triggered at a residual current of 300 mA (recommended). RCD of other specifications can also be used according to local standard.

6.4 EPS Output Connection

If you want to use the energy storage system to power the house (as a standalone system or during Grid failure), the EPS connector should be used and the EPS function should be enabled during setup. Otherwise, you could leave the EPS port disconnected.

The EPS output port is only for critical loads connection.

 WARNING	
<ul style="list-style-type: none">• The grid voltage and frequency must be in the permissible range.• Risk of inverter damage due to incorrect cable connection. Do not connect the grid power wires to EPS port.• An independent circuit breaker must be installed on the EPS side to cut off the inverter from EPS loads when necessary.• Decide which household appliances should be included in the EPS circuit and carry out any required re-wiring.	

Wiring Connection Procedure:

Step 1: Assembling the EPS Connector (reference to Grid connector).

Make sure Live/Neutral/PE wires are correct.

Step 2: Connecting the EPS cable to the inverter

- Unscrew the cap on the EPS port.
- Insert the EPS cable into the EPS port on the inverter until there is a "Click" sound.
- Check all the wires are firmly installed.

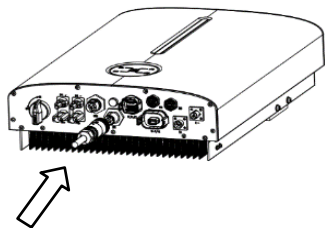

6.5 PV Connection

 DANGER
<p>Danger of electric shock!</p> <ul style="list-style-type: none"> • The PV array will generate lethal high voltage once exposed to sunlight. Ensure all cables are voltage-free before performing electrical operations. • Do not connect the AC circuit breaker before finishing electrical connection.

 WARNING
<ul style="list-style-type: none"> • Make sure the PV arrays are well insulated to ground before connecting it to the inverter. • Make sure the voltage, current and power ratings of the PV arrays are within the permissible range. • Make sure polarity is correct. The inverter will not function properly if any PV polarity is reversed. • The 3.68kW/6kW inverter is designed with 2 MPPT trackers, if the inputs of the PV panels are paralleled, please consult with your local distributor for technical support. • To avoid any malfunction, do not connect any PV Arrays with possible current leakage to the inverter. For example, grounded PV Arrays will cause current leakage to the inverter. • Make sure DC switch on "OFF" position. Otherwise please use an external PV switch to cut off the PV connection during wiring and when necessary.

NOTICE
<ul style="list-style-type: none"> • Use IEC61730 class-A Rating PV Arrays. • To ensure IP65 protection, use the right PV plugs in the package. • Damage to the device due to the use of incompatible terminals shall not be covered by the warranty. • All wiring must be performed by qualified personnel.

Wiring Connection Procedure:

The AC cable should be prepared by customers. LIVOLTEK provides corresponding PV connectors in the scope of delivery for quick connection of PV inputs. To ensure IP65 protection, use only the supplied connector or the connector with the same ingress of protection.

Model	Wire Size	Cable	Beaker
3KVA	10-12AWG	4-6mm ²	230/25A
5-6KVA	10-12AWG	4-6mm ²	230/32A

Step1: Assembling the PV Connectors

- Strip the insulation from each PV cable by 6mm –8 mm.
- Assemble the cable ends with the crimping pliers.
- Lead the cable through the cable gland and insert the crimp contact into the insulator until it snaps into place. Gently pull the cable backward to ensure firm connection.
- Tighten the cable gland and the insulator.

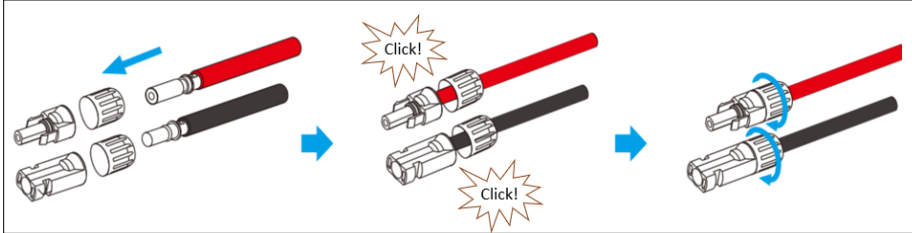
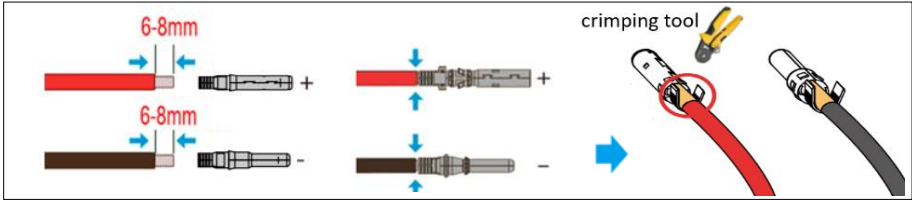

NOTICE

- DO NOT crimp the two metal sheets (below picture).
- These are fixing structure of metal core and its plastic shell. Crimping of the two metal sheets will result in failure of assemble, which may cause contact problems, and even fire in extreme cases.
- Check the cable connection of the PV string for polarity correctness and ensure that the open circuit voltage in any case does not exceed the inverter input limit of 600V.

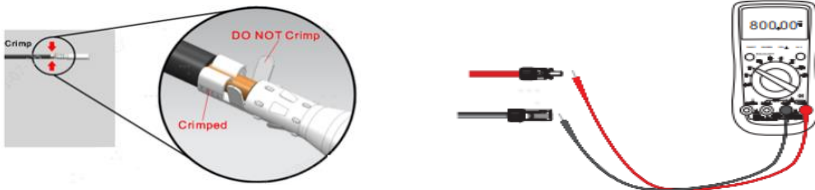

Step 2: Connecting the PV cables to the inverter

- Connect the PV connectors to the corresponding terminals until a “click” sound is heard.
- Seal the unused PV terminals with the terminal caps.

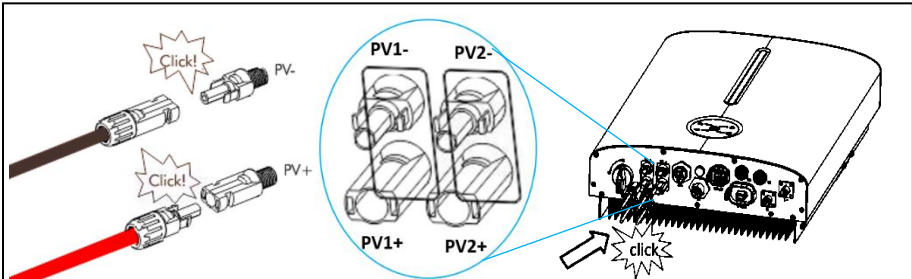

NOTICE

- Check the positive and negative polarity of the PV strings, and connect the PV connectors to corresponding terminals only after ensuring polarity correctness.
- Arc or contactor over-temperature may occur if the PV connectors are not firmly connected in place, and LIVOLTEK shall not be held liable for any damage caused due to this operation.
- If the DC input is connected inversely and the DC switch has been rotated to "ON", do not operate immediately. Otherwise, the equipment may be damaged. Please turn the DC switch to "OFF" and remove the DC connector to adjust the polarity of the strings when the string current is lower than 0.5A.

6.6 Battery Connection

This section mainly describes the cable connections on the inverter side. Refer to the instructions supplied by the battery manufacturer for the connections on the battery side and configuration.



DANGER

- Be careful against any electric shock or chemical hazard.
- A short circuit in the battery may cause personal injury. The instantaneous high current caused by a short circuit can release a large amount of energy and may cause a fire.
- Ensure that the open circuit voltage of the battery is within the permissible range of the inverter.
- Only use properly insulated tools to prevent accidental electric shock or short circuits. If insulated tools are not available, use electrical tape to cover the entire exposed metal surfaces of the available tools except their tips.
- Before connecting the battery cable, ensure the switches of inverter and the battery are all disconnected.
- Connect battery cables with correct polarity. If battery cables are reversely connected, the solar inverter may be damaged.
- It is forbidden to connect and disconnect the battery cables when the inverter is running, otherwise it may cause electric shock.
- Do not connect one battery pack to more than one inverter at the same time. Otherwise, it may cause damage to the inverter.
- It is forbidden to connect loads between the inverter and batteries.
- All wiring must be performed by a professional person.

NOTICE

- The hybrid inverter is not connected to a battery and does not support off-grid operation functions.

6.6.1 Li-Ion Battery Connection

Battery connection diagram

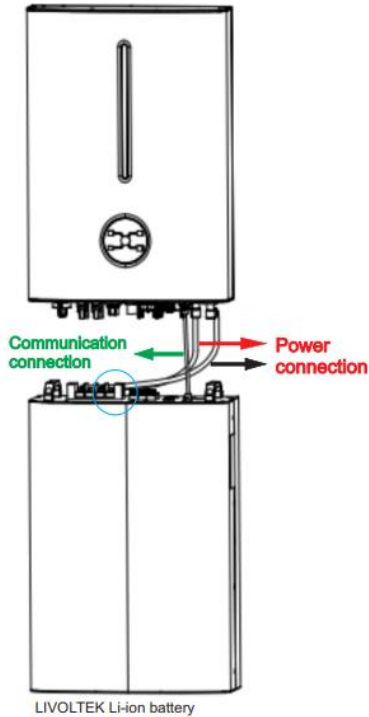

Note: Please be careful of any electric shock or chemical hazards. For batteries without a built-in DC breaker, make sure that an external DC breaker ($\geq 125A$) connected.

NOTICE

- The battery used with the inverter shall be approved by the inverter manufacturer. This inverter can only be connected with **LIVOLTEK** or **Pylontech** low-voltage lithium batteries with nominal voltage from 40V to 60V now. If you choose other lithium batteries, please consult LIVOLTEK for compatibility. Otherwise, the inverter will not work normally.
- For safe operation and compliance, a two-pole DC circuit breaker with overcurrent protection should be installed between the inverter and the battery.
- If you do not have battery now, you can float BAT terminal, and this hybrid inverter will only work like a PV inverter.

Notes:

Prepare battery cables with a conductor cross section of 25 mm² because the maximum battery current is >100A. Use the right BAT plugs within the scope of delivery.

- If the connectors of the battery power cables to battery side is not assembled, you need to contact with your battery vendor for detailed information.
- For LIVOLTEK Li-Ion battery, you should cut off one pair connectors of the battery power cables, and change them to water-proof BAT plugs in the inverter package.

Wiring Connection Procedure:

Step 1: Assemble the battery cable Connectors

- Remove an appropriate length of the insulation layer from the positive and negative power cables using a wire stripper.
- Insert the exposed areas of the positive and negative power cables into the BAT plugs respectively and crimp them using a crimping too.
- Ensure the correct polarity of batteries before connecting to the inverter.

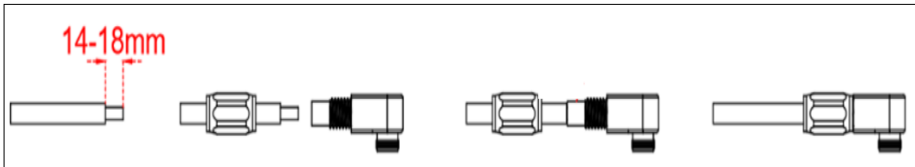

Step2: Connect the Battery cables to the inverter

- Insert the battery plugs into the corresponding BAT+ and BAT- terminals at the bottom of the inverter.
- Ensure that the connectors are securely in place.

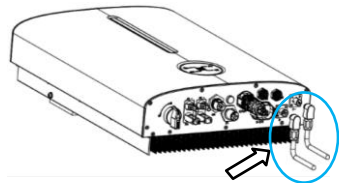

Step 3: Connect the Battery cables to the Battery

- Connect the Battery cable to the Battery and make sure the positive and negative poles are correct.
- Refer to the instructions supplied by the battery manufacturer for the connections on the battery side.

6.6.2 BMS Cable Connection

NOTICE

- If choosing Li-Ion battery, make sure to connect the BMS communication cable between the battery and the inverter.
- The CAN cable enables the communication between the inverter and the Li-Ion Battery.
- Communication interface between inverter and battery is CAN with a RJ45 connector.
- The battery communication can only work when the battery BMS is compatible with the inverter.

Wiring Connection Procedure:

Step1: Assemble the BMS cable Connector

- Prepare a communication cable and insert the BMS cable connector which can be found in the accessory box.
- Crimp the communication cable with an Rj45 plug which is inside of the BMS cable connector.

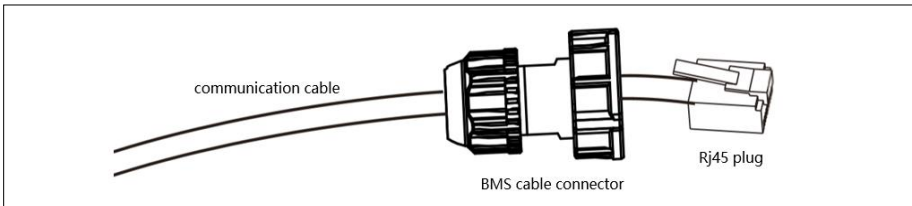

Step2: Connect the BMS cable to the inverter

- Insert the BMS cable connector into BMS port on the inverter and screw it tightly.
- Then insert other side of communication cable into CAN port on the battery.
- Make sure the Li-Ion battery BMS port connects to the inverter is Pin to Pin.

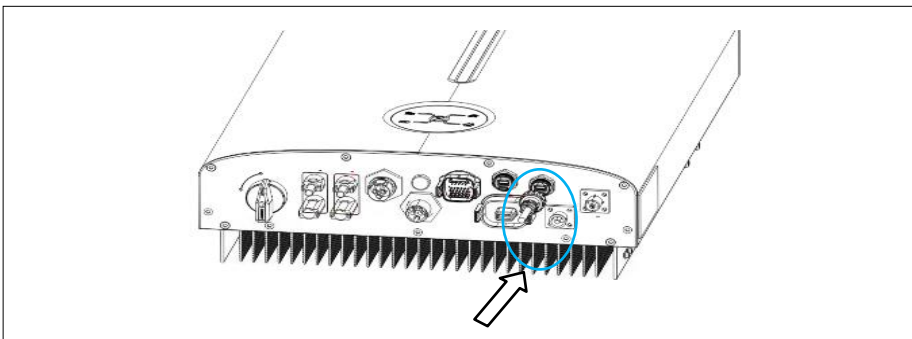

BMS Pin Definition

NOTICE

The BMS Pin Definition for battery from the **Pylontech** and **LIVOLTEK** are different. Make sure the right wire sequence, otherwise will cause failure.

BMS Pin Definition for Li-Ion Battery from LIVOLTEK

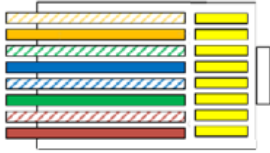

Orange white	1. BMS_CAN_H
Orange	2. BMS_CAN_L
Green white	3. NULL
Blue	4. GND
Blue white	5. NULL
Green	6. NULL
Brown white	7. NULL
Brown	8. NULL

BMS Pin Definition for Li-Ion Battery from Pylontech

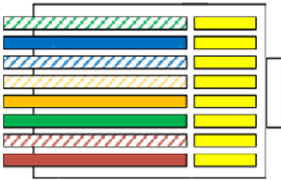

Green white	1.NULL
Blue	2.GND
Blue white	3.NULL
Orange white	4.BMS_CAN_H
Orange	5.BMS_CAN_L
Green	6.NULL
Brown white	7.NULL
Brown	8.NULL

6.6.3 Lead-acid Battery Connection

NOTICE

- The hybrid inverter can be connected to proper capacity lead-acid battery with a nominal voltage at 48V.
- For safe operation and compliance, a two-pole DC circuit breaker with overcurrent protection should be installed between the inverter and the battery.

Battery Power cable Connection:

Different brands of lead-acid batteries have different installation methods, please refer to the battery manual for details.

6.6.4 NTC Cable Connection

The inverter has integrated a NTC temperature sampling port for lead-acid batteries. With the external NTC cable installed, it can sample the temperatures of the battery cabinet to avoid damage caused by low or high temperature. The protective temperature of lead-acid battery ranges from -25°C to $+60^{\circ}\text{C}$.

Wiring Connection Procedure:

Step 1: Take out the NTC cable and a PVC tape in the package of inverter.

Step 2: Make the tape adhere to NTC interface.

Step 3: Insert the two pins of NTC into Multi COM port of inverter, and then glue the end of the NTC cable to the surface of the lead-acid battery (any place but must be nonmetallic) with PVC tape.

NTC Cable Pin Definition

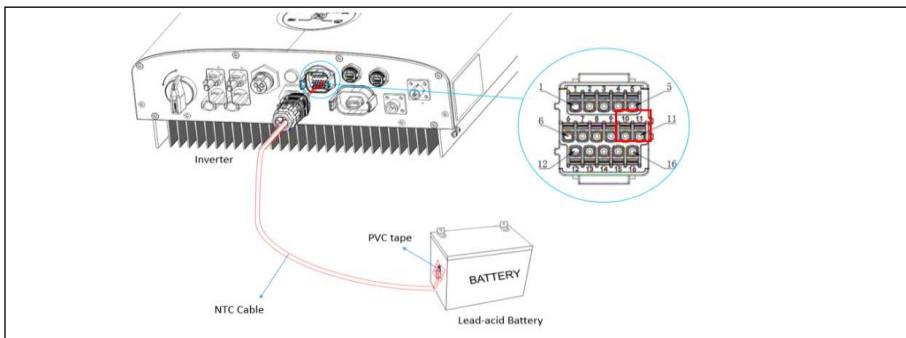
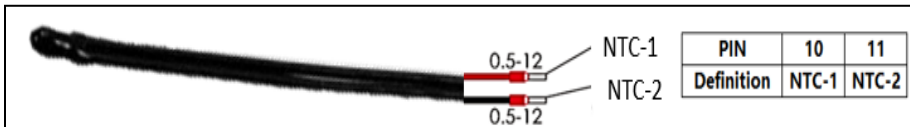

Step 4: The wire diameter of the NTC cable is smaller than the sealing port of the Multi COM connector. It is recommended to add some rubber cement into the sealing port after installation to make it waterproof.

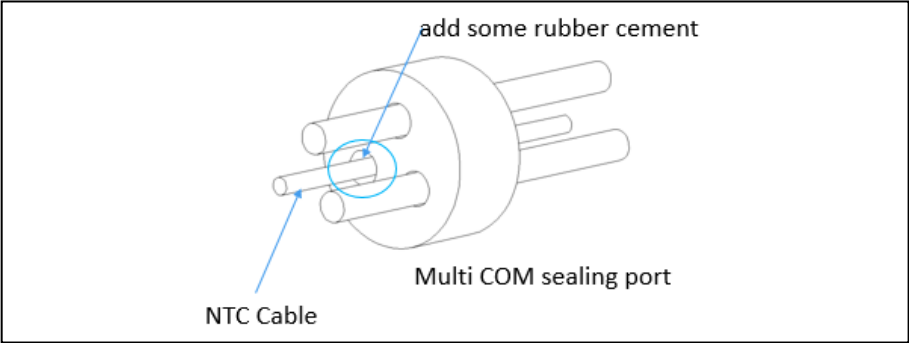

6.7 WIFI Connection

The inverter provides a communication port, which can collect data and transmit data of the inverter to the monitoring website via Wi-Fi stick.

WIFI Dongle (Wi-Fi & Bluetooth 2in1 function) implements communication with Cloud server through wireless network to monitor the inverter's data status. For more details, refer to WIFI Application Manual.

Wiring Connection Procedure:

Step 1: Remove the waterproof lid from the Wi-Fi/4G terminal.

Step 2: Insert the Wi-Fi stick into the communication port.

Slightly shake it by hand to determine whether it is installed firmly.

Step 3: Build the connection between the inverter and router. Please refer to the Pocket Wi-Fi user manual to configure the WLAN.

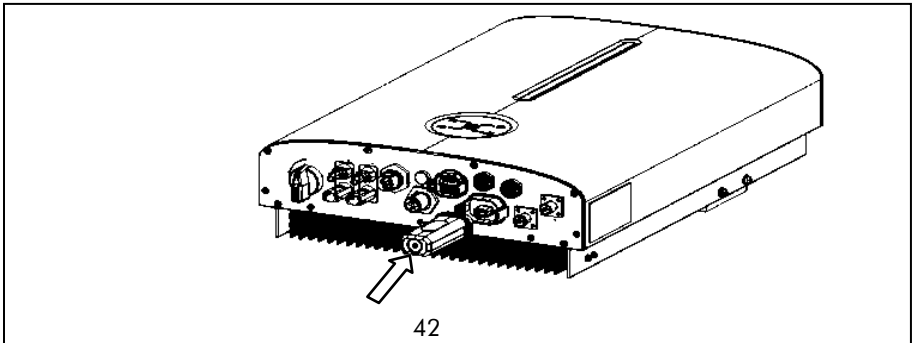

6.8 DRM Connection

The inverter supports the demand response modes as specified in the standard AS/NZS 4777. The inverter has integrated a terminal block for connecting to a DRED, as shown in the following figure.

Mode	Requirement
DRM0	Operation disconnect device
DRM1	Do not consume power
DRM2	Do not consume more than 50% of rated power
DRM3	Do not consume more than 75% of rated power AND Source reactive power if capable
DRM4	Increase power consumption (subject to constraints from other active DRMs)
DRM5	Do not generate power
DRM6	Do not generate more than 50% of rated power
DRM7	Do not generate more than 75% of rated power AND Sink reactive power if capable
DRM8	Increase power generation (subject to constraints from other active DRMs)

“DRM” Connector Pin Definition

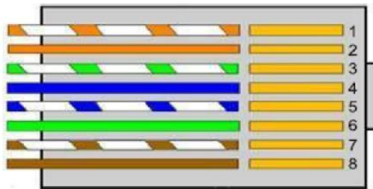

1. DRM1/5
2. DRM2/6
3. DRM3/7
4. DRM4/8
5. 3.3V
6. DRM0
7. 3.3V
8. GND

Wiring Connection Procedure:

Step 1: Unscrew the swivel nut from DRM port.

Step 2: Lead the cable through the cable gland.

Step 3: Remove the cable jacket and strip the wire insulation.

Step 4: Plug the wires into the corresponding terminals.

Step 5: Fasten the swivel nut with a torque of 4–5N.m and connect the other end to the DRED (DRED device is not provided by LIVOLTEK).

6.9 Multi COM Terminal Connection

The inverter provides 16pin terminals to facilitate you to install CT or Smart meter, parallel function or EV charger.

NOTICE	
•	Follow the pin definition below to connect the Multi com communication cables.
•	Do not remove the resistor or short circuit wire unless you are going to use the corresponding PINs.

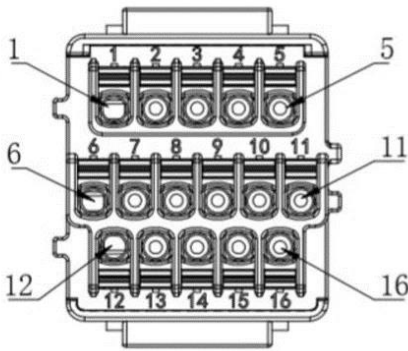

Signal definitions

Pin	Definition	Description	Pin	Definition	Description
1	Meter-485B	485 contact interface for Smart meter	9	SYNC-TXA	
2	Meter-485A		10	NTC-1	NTC cable for Lead-acid battery temperature sensor
3	CT+ (Red)		11	NTC-2	
4	CT- (White)	CT contact interface	12	EV_485A	485 contact interface for EV charger or Parallel 2 Port
5	ARM-485B		13	EV_485B	
6	Para_CANH	CAN contact interface for parallel connection	14	ARM-485B	
7	Para_CANL		15	Dry-	Dry contact interface for generator
8	GND-C		16	Dry+	

16pin terminals show as below:

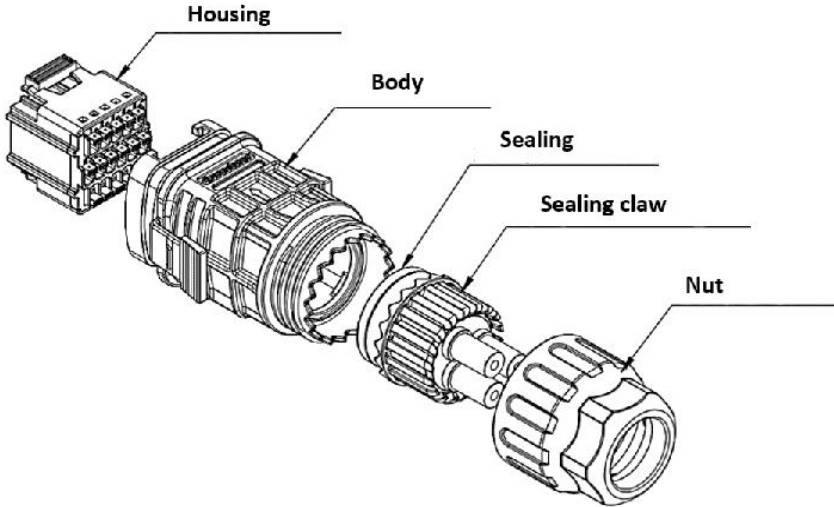

Wiring Connection Procedure:

- Step 1:** Prepare the communication cable and remove the plug of the communication terminal.
- Step 2:** Dismantle the communication module and take out the pin terminal. To avoid water and dust, keep the rubber plug to seal the unused holes.
- Step 3:** Insert the communication cable into the corresponding pins terminal to realize the RS485 communication function.
- Step 4:** Assemble the communication module and plug it into the communication terminal.

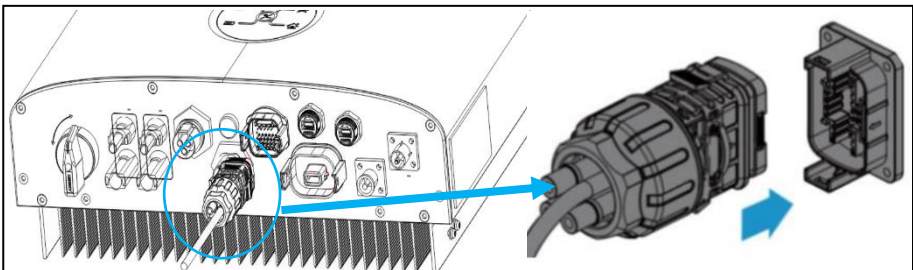

Notes: Assemble the communication module and plug it into the communication terminal directly if you are not going to use the communication functions.

6.9.1 CT Connection

The hybrid inverter is equipped with the feed-in power limit function, so as to meet the requirements of some national standards or grid standards for the output power at the grid connection point. For the setting of feed-in power limit, refer to the section “Feed-in Limitation”

The CT (Current transformer) in the package of inverter is compulsory for this hybrid system installation. Which measures the value and direction of AC current. Thanks to its built-in metering chip, the hybrid inverter enables the export power to the grid does not exceed a preconfigured limit.

NOTICE	
•	No meter or CT to the inverter will cause fault.
•	The smart meter must be authorized by LIVOLTEK, any third party or non-authorized meter may not match with the inverter.
•	LIVOLTEK will not take the responsibility if the meter is unavailable.
•	The color of the wire is not fixed to a red & black combination, it could also be red & white or blue & white, etc. Please pay close attention to the corresponding interfaces when wiring.

NOTICE	
Do not place the CT on the N Wire or the earth wire.	
Do not place the CT on the N and L wire simultaneously.	
Do not place the CT with the arrow pointing to the inverter side.	
Do not place the CT on the non-insulated wires.	
Important: The arrows direction on the CT must point to the inverter side.	

CT Pin Definition

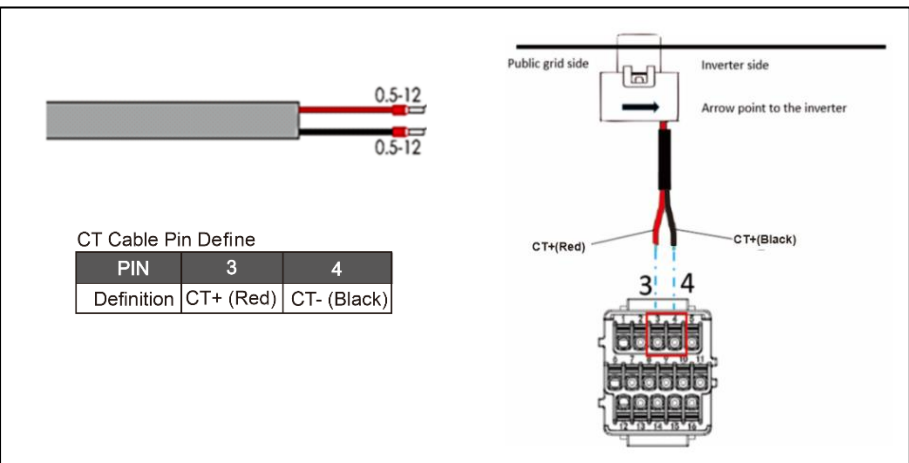

6.9.2 Smart Meter Connection

When customer needs to use meter to monitor the energy flow, the meter terminal connection steps are as follows:

NOTICE

Make sure AC cable is totally isolated from AC power before connecting Smart Meter.

One Smart Meter can only be used for one hybrid inverter.

Normally the smart meter should be placed in or near the grid distribution box right after the billing meter.

Please use the smart meter cable in the accessory box for communication.

Wiring Connection Procedure:

Step 1: Connect the signal cable to the signal cable connector.

Step 2: Connect the signal cable connector to the Multi COM port.

Step 3: Secure the signal cable connector

Meter Connector Pin Definition

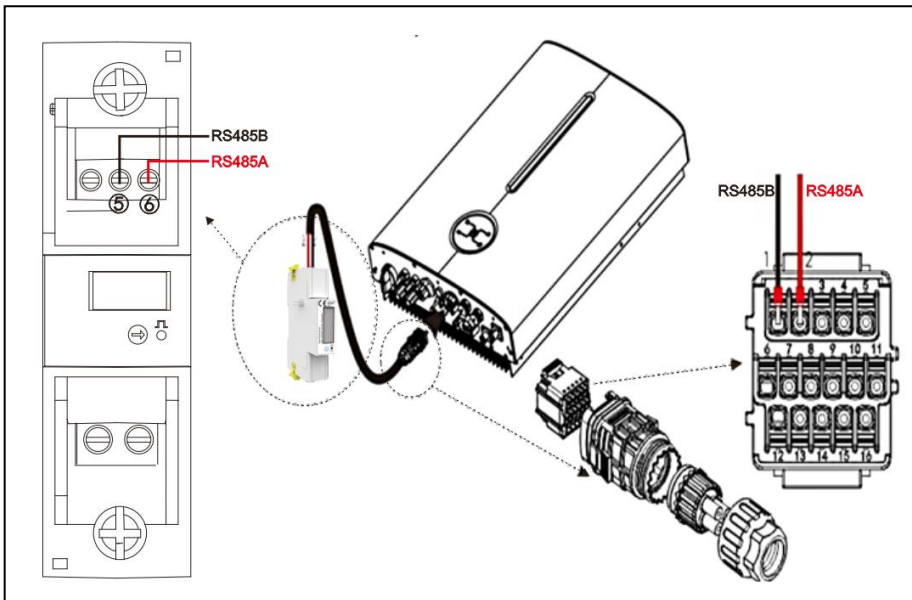
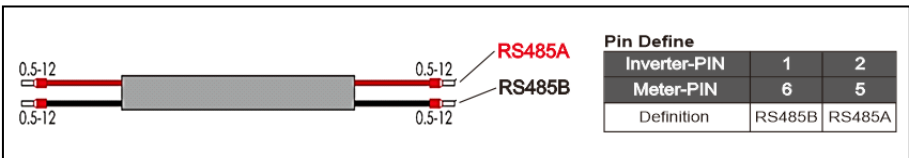

6.9.3 EV charger Connection

This inverter is ready for you to use solar energy to charge your electric car. For more details, please refer to the LIVOLTEK EV charger user manual.

Notes: This inverter can be only connected with LIVOLTEK EV charger now.

6.9.4 Auto- Transformer Connection (Optional)

For backup power capability, this inverter enables you to split the 240 volts into two legs of 120 volt and to balance the load between the two legs by installed with LIVOLTEK auto-transformer box for the critical loads.

For more details, please refer to the LIVOLTEK Auto-Transformer user manual.

6.9.5 Installation Verification

Check the following items after the inverter is installed.

- No other objects put on the inverter.
- All screws especially the screws used for electrical connections are tightened.
- The inverter is installed correctly and securely.
- Ground, AC, DC and Communications cables are connected tightly correctly and securely.
- Check there is no open circuit or short circuits at AC and DC terminals using multi-meter.
- Idle terminals are sealed.
- All safety warning symbols are intact and complete on the inverter.

7. System Operation

7.1 LED Display

The inverter operation status can be obtained from observing LED indicator status.

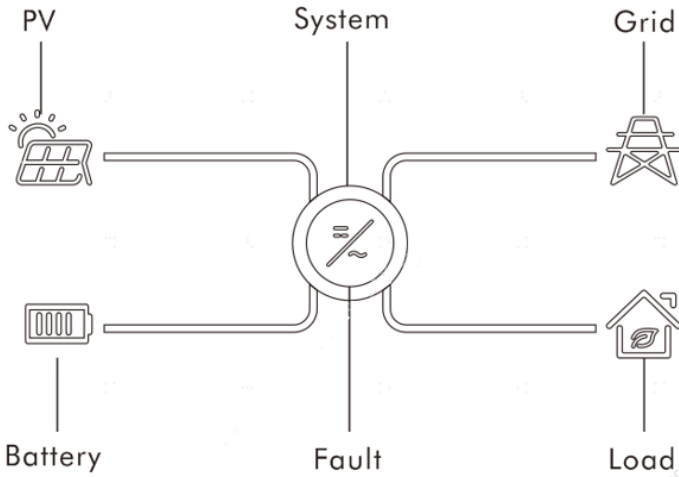

Color	Status	Description
Green	on	The inverter is running normally
	off	Other statuses except Running
Red	on	Fault occurs
	off	No fault occurs
Green/Red	blink	System startup or updating

You can monitor & set data of the inverter through the LIVOLTEK APP. For details about operation, refer to APP User Manual. APP User Manual is available for free from website.

LED indicator status for common fault of the inverter:

Error Message	PV	BATTERY	GRID	LOAD	SYSTEM	FAULT
Starting up	X	X	X	X	★	★
Normal status	◎	◎	◎	◎	●	X
WI-FI communication	◎	◎	◎	◎	●	X
PV energy weak	◎	◎	◎	◎	●	X
PV over Volt	●	◎	◎	◎	X	●
PV over current	●	◎	◎	◎	X	●
PV Strings Reverse	●	◎	◎	◎	X	●
EPS Volt Fault	◎	◎	◎	●	X	●
EPS Over Load	◎	◎	◎	●	X	●
EPS Short Fault	◎	◎	◎	●	X	●
BMS Lost	◎	●	◎	◎	X	●
BMS Fault	◎	●	◎	◎	X	●
Inter CKT Fault	●	●	●	●	X	●
Inter Com Fault	●	●	●	●	X	●
EEPROM Fault	●	●	●	●	X	●
Leakage Over Current	●	●	●	●	X	●
Earth Fault	●	●	●	●	X	●
MET/CT Fault	●	●	●	●	X	●
PAL Multi Master	X	X	X	X	X	●
PAL Com Fault	X	X	X	X	X	●
PAL SN Fault	X	X	X	X	X	●
PAL HWC Fault	X	X	X	X	X	●
PAL FWC Fault	X	X	X	X	X	●
PAL SLV Fault	X	X	X	X	X	●

● means light on, x means light off, ★ means blink, ◎ means keep original status.

7.2 Start-up Procedures

Check the following items before starting the inverter:

- The country marked on the packing box is in accordance with the installation site.
- The inverter is correctly and firmly fastened to the mounting bracket on the wall.
- All cables are connected according to chapter 6;
- All unused terminals are properly sealed.
- AC circuit breaker is correctly connected between inverter GRID port & GRID, circuit breaker is disconnected.
- AC circuit breaker is correctly connected between inverter EPS port & critical loads, circuit breaker is disconnected.
- For Li-Ion battery, ensure that the BMS cable has been correctly connected.
- For the lead-acid battery, ensure that the NTC cable has been correctly connected.

If all of the items mentioned above meet the requirements, proceed as follows to start up the inverter for the first time.

Step 1: Power on the Grid

- Connect the AC circuit breaker.

Step 2: Power on the Battery

- Connect the external DC circuit breaker between the inverter and the battery, then power on the battery manually if a battery is equipped.

Step 3: Power on the PV

- Rotate the DC switch to "ON". Wait for a moment and the inverter will start a self-test procedure.

Step 4: Switch on the loads

- The load parameters should show.

Step 5: Configure the Wi-Fi stick

- Establish communication connection between the mobile phone and Wi-Fi stick, then set initial protection parameters. Refer to LIVOLTEK APP Operation Instructions for details.

Step 6: Self-test in accordance with CEI 0-21 (Italy Only)

- The self-test is only required for inverters to be commissioned in Italy. During the self-test, the inverter will consecutively check the reaction times for: overvoltage, under-voltage, maximum frequency and minimum frequency.
- Please use the LIVOLTEK APP to initiate the self-test procedure and get the test results. Refer to "Settings on the APP" for details.

Step 7: Observe the LED indicator

- Observe the LED indicator to ensure that the inverter operates normally.

7.3 Shut down Procedures

For maintenance or other service work, the inverter must be switched off. Proceed as follows to disconnect the inverter from the AC and DC power sources.

Notes: Please strictly follow the following procedure. Otherwise, it will cause lethal voltages or unrecoverable damage to the inverter.

Step 1: Turn off the loads;

Step 2: Turn off the PV;

Step 3: Turn off battery;

Step 4: Turn off the main grid switch;

Step 5: Wait for at least 5 minutes after the LED and graphical display black out for the internal circuits to discharge energy;

Step 6: Disconnect all the power cables;

Step 7: Disconnect all the communication cables, Remove the Wi-Fi stick;

Step 8: Remove the inverter from the wall, also remove the bracket if necessary;

Step 9: Pack the inverter with the original carton, and store it.

8. APP Operation

The hybrid inverter can be configuration via WIFI Stick (Wi-Fi & Bluetooth 2in1 function), which is the easiest way to ensure a simple, highly reliable communication connection.

LIVOLTEK portal is a platform that the inverter connects through WIFI Stick, and upload the data to it every 5 minutes. You can log in account at any time through a computer, IOS or Android to achieve real-time display and remote control.

Web: <https://www.livoltek-portal.com/>

APP: Search for Mylivoltek on Apple App Store, Google Play and download the latest installation package.

8.1 User interface on the APP

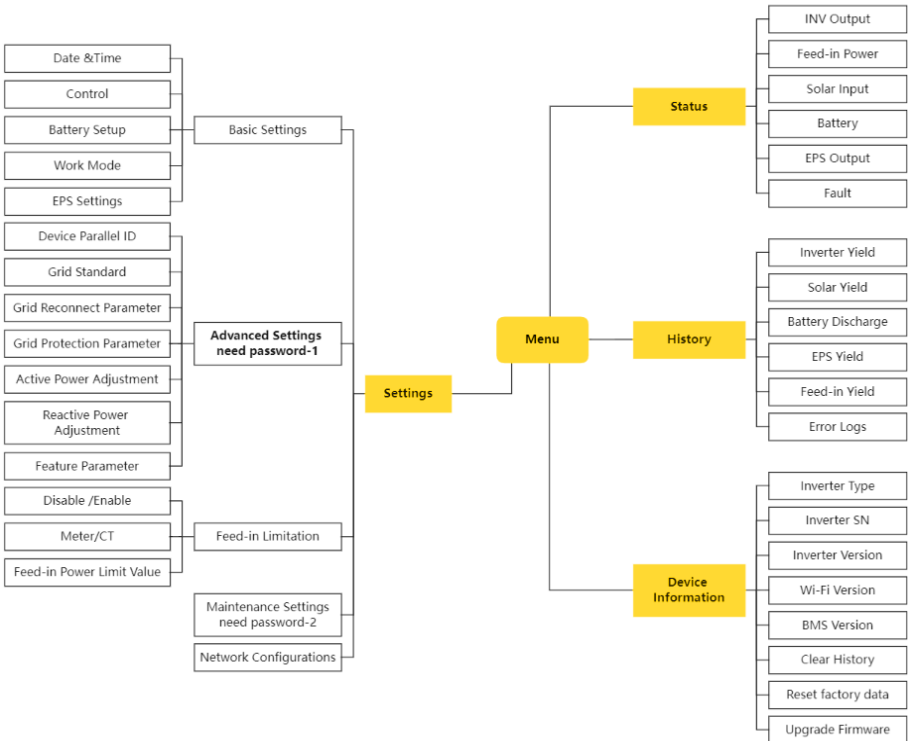

Notes: The advanced setting and Maintenance settings can only be check and set via local mode or Web.

8.2 Wi-Fi Configuration

Preparation

- Power on inverter
- Power on router and check the wireless networks that mobile phone joined

Step 1: Install LIVOLTEK APP

APP is available from Apple App Store, Google Play, and Android APK. Scan the QR Code below to download the APP on your smartphone.



Step 2: Connect the Inverter

- Open Livoltek APP, choose "Local Mode" ----> "Bluetooth Mode"----> "INV".
- Find your inverter SN (named with "BLF-HP- last few digits of SN").
- Click on "setting" ---->"Network Configurations"
- Press "Reset" key on PSD200-FIDongle about 3~5 seconds. Then the first LED will blink.
- Enter wireless network name & password (same network your phone configured to)
- Click on "Confirm" and wait 10s, "Success" will display on the APP if successful.

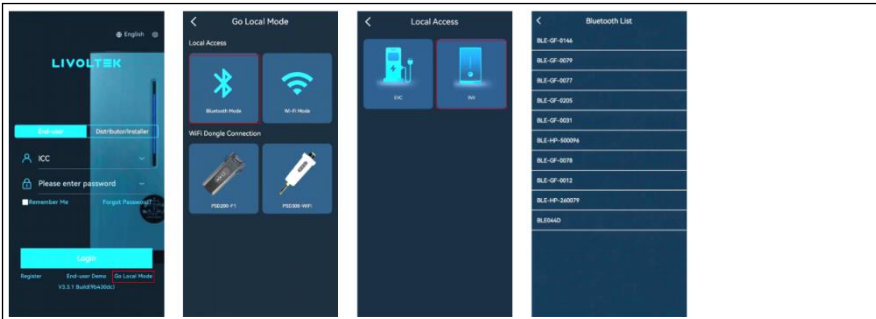

Step 3: Wi-Fi Configuration

- Click on "setting" ---->"Network Configurations"---->"Next".
- Press "Reset" key on PSD200-FIDongle about 3~5 seconds. Then the first LED will blink.
- Enter wireless network name & password (same network your phone configured to)
- Click on "START" and wait 10s, "Success" will display on the APP if successful.

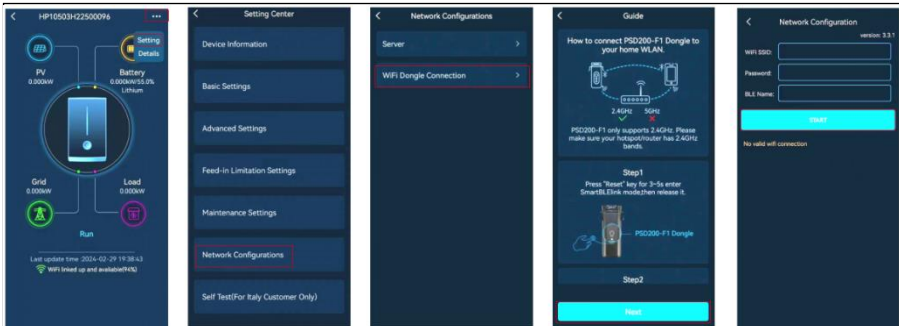

8.3 Register an account

Open the app or web and login with the username & password. Register it first if you don't have an account, which provides access to the remote monitoring and management.

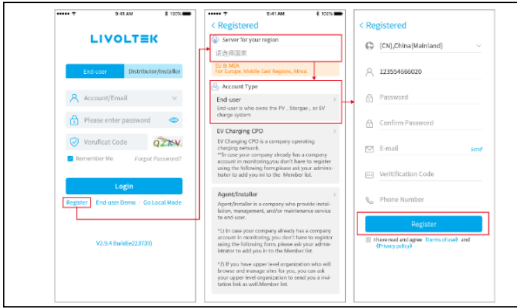

NOTICE

- There are two different accounts for end users and business (agents/installers), with different account authorizations.
- Business accounts can only be registered through web.
- Only end user accounts can be registered through the APP.
- The agent/installer can create a sub-account for the end user after the power site (PV plant) is created.

8.4 Create a site and add the inverter to the site

You can edit the site (PV Plant) information, add the new inverter to the site, delete the site, expand the list of added inverters of the site and set the electricity price.

8.4.1 Add Site

- Open the app and login with the username & password.
- Enter the "List" Page, touch "Add" button [+] at the top right of the page.
- Enter the Plant Name, choose the Installer, Time Zone, location and other basic information.
- For the location, click the "Map" to enter the map page, system will automatically locate your location.

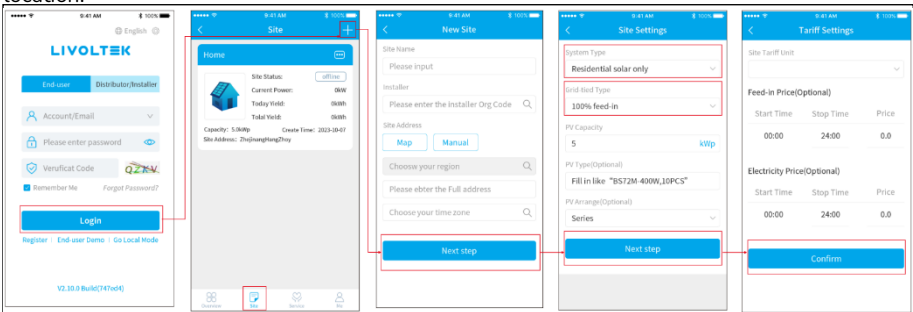

8.4.3 Add Device

- Touch "Add" button [+] at the top right of the PV site page to add a device.
- Choose your product model and enter SN number, then touch [confirm].

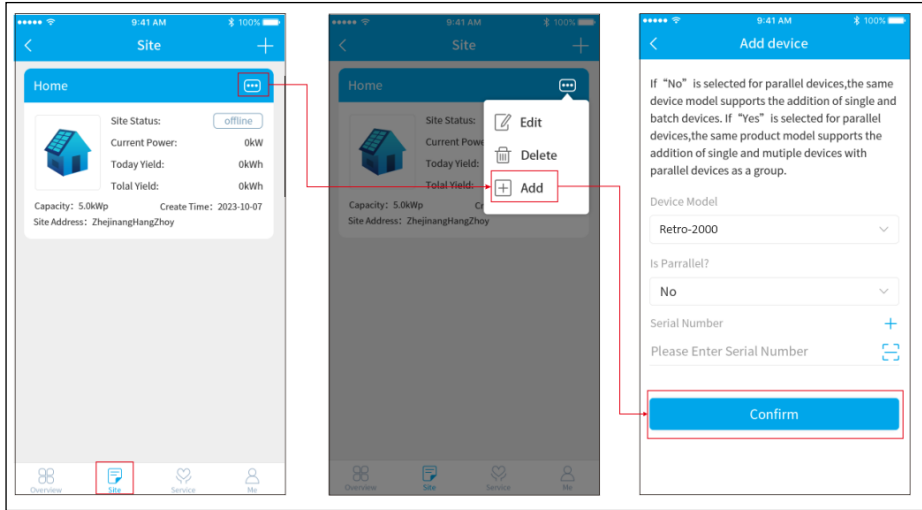

8.5 Setting on the APP

8.5.1 Home Page Overview

You can check Parameters of System. The status and data on this page might be a few minutes delay from the real-time inverter data

By touch the icons on the diagram, it will show the historical data of each part.

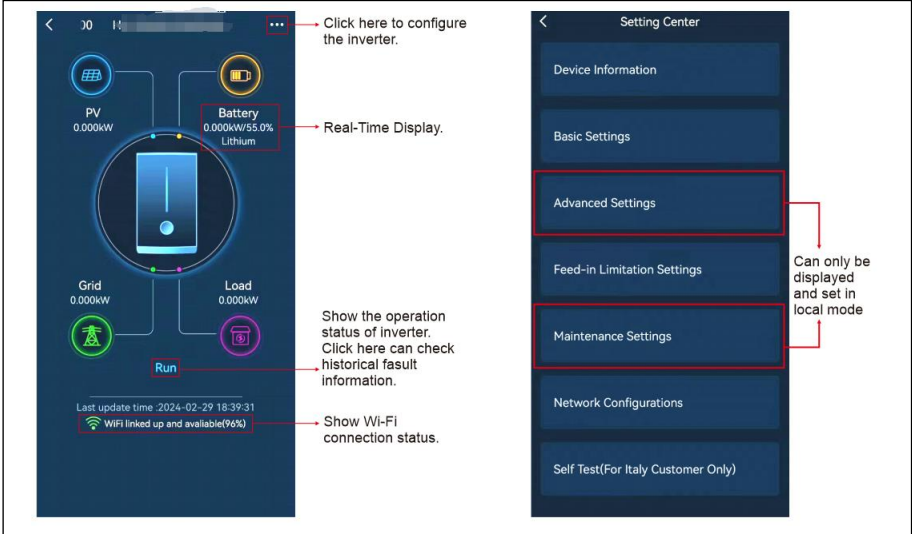

8.5.2 Basic Settings

You can set the inverter time, Restart the inverter, choosing work modes, battery type and set charging time period in Basic settings.

8.5.2.1 Emergency Charge

- Emergency Charge is design to avoid the damage caused by long time excessive discharge.
- It is recommended to manually click this button to charge the battery after installing the battery for the first time.
- The inverter cannot respond to the discharge command during emergency charge.
- In this mode, the battery will be charged to 54V, and it will exit this mode after 2 hours. But you can exit this mode by clicking "Restart" during this process.

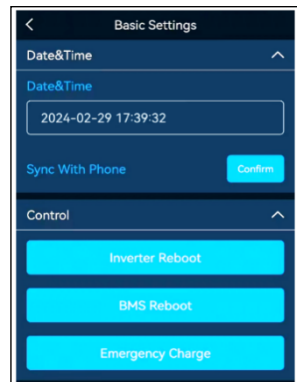

8.5.2.2 Select Work Modes

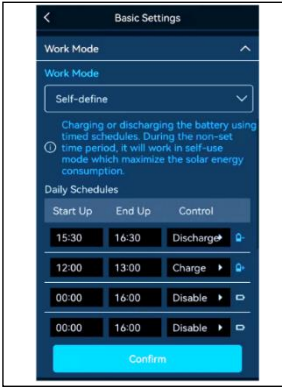

Work Modes decides the operation logic of the hybrid system. Make sure what you select is exactly what you want. The detailed description about the working modes, please refer to the chapter 3.4 Work Modes.

Self-Use Mode: The default mode for self- consumption.

Back-Up Mode: You can set the reserve percentage of the minimum battery state (Discharge End-up SOC @ Grid), for urgent use to support backup loads.

Self-Define Mode: You can set two charge time ranges as your need.

8.5.2.3 Battery Setting

① Select Battery Type

- The inverter supports Li-Ion and lead-acid batteries as well as no battery operation.
- The BMS cable must be connected when choose Li-Ion battery, otherwise the system will report BMS communication failure.

② Discharge End-up SOC @ Grid

It refers to the discharge cut-off SOC of the Li-Ion battery when the utility grid is available. The battery is not allowed to discharge if the capacity is lower than it.

③ Discharge End-up SOC @ EPS

It refers to the discharge cut-off SOC of the Li-Ion battery when the utility grid is not available. The battery is not allow to discharge if the capacity is lower than it.

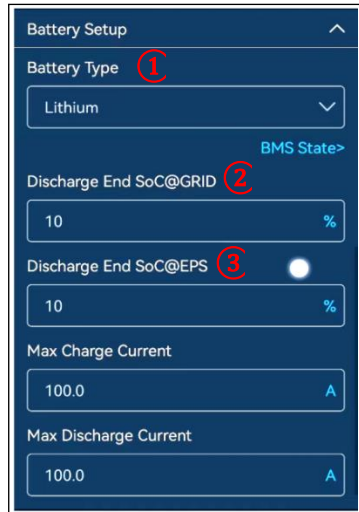

Notes: All the settings must be 100% honest to the battery specifications first. Both the two discharge End-up SOC set range is 10~100%.

8.5.2.3 EPS Setting

This hybrid inverter has two EPS modes that can be set, namely UPS and EPS, the default mode is UPS.

- UPS means an uninterruptible power supply. When there is utility grid, the inverter bypass to supply power to the loads. When there is a grid failure, it can utilize power from solar system & energy stored in the battery to supply power to critical load (Battery is necessary in this mode.)The energy switching time in this process is less than 16 milliseconds.

- The EPS (Emergency Power Supply) mode means the EPS port will only have power output when the grid failure. The energy switching time in this process is less than 2 seconds. But the standby power consumption of EPS mode is less than UPS mode, which can save more energy for the customer.

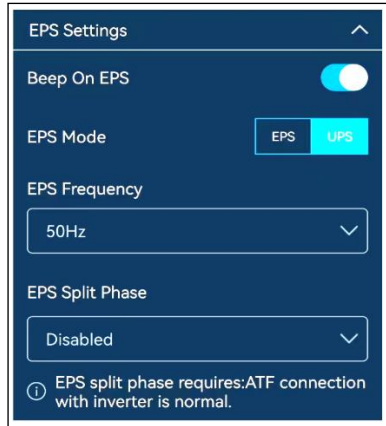

8.5.3 Advanced Settings

Advanced settings is generally customization for installation, lead-acid battery and protection value of grid. Please contact your installer or factory and enter the installer password(Default:hx123456).

AC Coupling

For the AC Coupled Inverter, this switch should be turned on.

Grid Standards

Grid standards means safety code. Generally, it is set before leaving the factory according to the shipping country and region. If your country is inconsistent with local regulations, you can choose here. Make sure to select the right safety country.

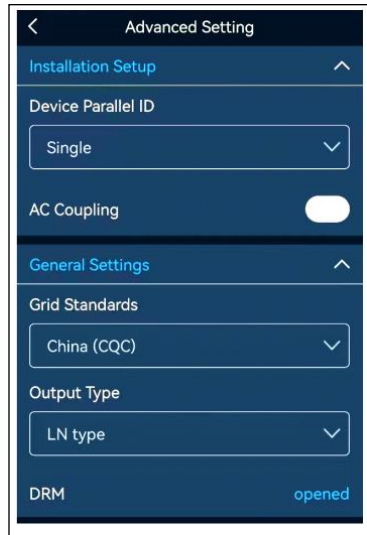

8.5.4 Feed-in Limitation Setting

The feed-in limitation is energy management solution for you to control the power that can be exported to grid to a specific limit.

Turn on to use if your grid company does not allow external power feed into grid or you do not want PV production exported to grid.

Notes: If you use this function and set a Power limit value, then PV production could be limited if consumer or battery charge power is low

In order to realize the function of feed-in power limit, the system must be installed with electricity meter or CT.

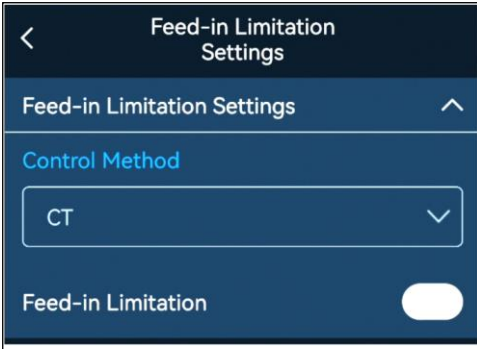

9. Troubleshooting and Maintenance



WARNING

Before maintaining and commissioning inverter and its peripheral distribution unit switch off all the charged terminals of the inverter, and wait at least 10 minutes after the inverter is powered off.

9.1 Troubleshooting

When the inverter has an exception, its basic common warning and exception handling methods are shown in the table below.

Alarm Name	Possible causes	Suggestion
PV1 Over Volt	PV input voltage is not within permissible range.	Check the voltage and number of PV modules and adjust it if need. Wait for recovery or restart the system.
PV2 Over Volt		
PV1 Over Current	PV input current is not within permissible range.	Check the PV input power and configuration. Wait for recovery or restart the system.
PV2 Over Current		
PV1 Strings Reverse	The cables of PV strings are connected reversely.	Disconnected the DC Switch. Check the cables of PV strings and reconnect the cables if need.
PV2 Strings Reverse		
PV Energy Weak	Insufficient power supply from PV strings.	When sunlight intensity weakens, no action is needed. Otherwise, check if there is shielded, or short circuit, open circuit etc. in the PV strings.
Leakage Over Current	The leakage current exceeds the permissible range.	Check PV cable ground connection and adjust it if need. Contact your dealer for technical support if the error happens again.
Earth Fault	The earth fault occurs	Check the connection of grounding and the L-line & N-line and adjust it if need. Contact your dealer for technical support if the error happens again.
AC Volt Fault	AC voltage is not within permissible range.	Check the setting of the safety country and AC voltage (L & N).

AC Freq Fault	Grid frequency is not within permissible range.	Check the setting of the safety country, frequency and the connection of AC cables. Contact your dealer for technical support if the error happens again.
EPS Volt Fault	Output Voltage abnormal (Inverter voltage is higher than 260Vac)	Check if the load power is within the EPS power range and the AC output wires are connected well.
EPS Over Load	Overload error. The inverter is overload 110% and time is up (more than Five time)	Reduce the connected load by switching off some equipment, and wait for the recover. Restart the inverter and contact your dealer for technical support if the error happens again.
EPS Short Fault	EPS output short circuit	Check the wires connection. Restart and contact your dealer for technical support if the error happens again.
Inter CKT Fault	BUS Voltage (AC) is too high.	Wait for inverter recovery. Contact your dealer for technical support if the error happens again.
Inter CKT Fault	Over Current fault.	
Inter CKT Fault	Component failure.	
Inter Temp High	The ambient temperature inside the inverter exceeds the upper limit.	Check the air flow of the unit, then close it and wait for 30mins. Contact your dealer for technical support if the error happens again.
BAT Temp High	Battery (Lead-Acid) temperature is not within permissible range.	Check the environment temperature. Contact your dealer for technical support if the error happens again.
BAT Volt Fault	Battery voltage is not within permissible range.	Check the spec and quantity of battery and the connection. Contact your dealer for technical support if the error happens again.
BMS Lost	BMS Communication lost.	Check battery type and communication of the BMS cable. Restart the inverter and contact your dealer for technical support if the error happens again.
Low battery	The battery voltage is too low.	Re-charge battery and contact your dealer for technical support if the error happens again.

Inter CKT Fault	Over Current occurs during battery charging or discharging.	Restart the inverter and contact your dealer for technical support if the error happens again.
	BUS Voltage is too high or internal failed	
Inter Com Fault	Internal communication failure (ARM&DSP).	
EEPROM Fault	Internal EEPROM Component (ARM) damaged.	
BMS Fault	BMS communication failure.	
PAL Com Fault	Communication faults between the master and the slave inverter.	Check the parallel communication cable and adjust it if need. Restart the inverter and contact your dealer for technical support if the error happens again.
PAL Multi Master	The master-slave identity of the inverter is set incorrectly.	Check the number of the inverters and adjust it if need.
PAL SN Fault	The product models or output power of the two inverters do not match.	Check the product model and power of the parallel inverters and replace it if there is inconsistent. Contact your dealer for technical support if the error happens again.
PAL HWC Fault	The hardware codes are not compatible	Contact your dealer for technical support.
PAL FWC Fault	The firmware codes are not compatible	
PAL SLV Fault	Parallel system stop due to various reasons.	Check the 2 inverters working status. Restart the inverters and contact your dealer for technical support if the error happens again.
MET/CT Fault	Meter or CT self-check fault.	Check the power cable connection. Contact your dealer for technical support if the error happens again.

9.2 Routine Maintenance

To ensure that the inverter can operate properly for a long term, you are advised to perform routine maintenance on it as described in this chapter.

 CAUTION
<p>Risk of inverter damage or personal injury due to incorrect service!</p> <ul style="list-style-type: none"> Always keep in mind that the inverter is powered by dual sources: PV strings and utility grid. Before maintaining and commissioning inverter and its peripheral distribution unit switch off all the charged terminals of the inverter, and wait at least 10 minutes after the inverter is powered off.

Routine Maintenance

Check Item	Method	Period
System clean	Check the temperature and dust of the inverter. Clean the inverter enclosure if necessary.	Once every 6 to 12 months
System running status	Check whether the inverter is not damaged or deformed or can be operated with no abnormal sound.	
Cable entry	Check whether the cable entry is insufficiently sealed, or the gap is excessively large, and reseal the entry when necessary.	
Electrical connection	Check whether all cables are firmly in place. Check whether a cable is damaged, especially the part contacting the metal enclosure.	

9.3 Decommissioning

Perform the following procedures to remove the inverter:

Step 1: Disconnect all cables from the inverter including communications cables, DC input power cables, AC output power cables, and PGND cables.

Step 2: Remove the inverter from the bracket.

Step 3: Remove the bracket.

 WARNING
Before removing DC input connector double check DC input switch, is turned to OFF to avoid inverter damage and personal injury.

9.4 Disposal of the Inverter

The inverter and its packing case are made from environment-friendly materials. If the inverter service life has expired, do NOT discard it with household garbage; dispose the inverter in accordance with local environmental laws and regulations.

10. Technical Data

Technical Data	Hyper-2000	Hyper-3000	Hyper-3680	Hyper-4600	Hyper-5000	Hyper-6000
PV Input Data						
Max. Recommended DC Power (Wp)	3000	4500	5520	7500	7500	7500
Max. DC Input Voltage (V)	600					
Nominal DC Input Voltage (V)	360					
MPPT Voltage Range (V)	80-550					
MPPT Operating Voltage Range (Full-Load)(V)	150~520	220~520	135~520	180~520	180~520	225~520
Start-up Voltage (V)	80					
Start output Voltage(V)	100					
No. of MPPTs	1		2			
No. of Strings per MPPT	1		1/1			
Max. Input Current (A)	14		14/14			
Max. Short Circuit Current (A)	17.5		17.5/17.5			
AC Input						
Max. Apparent AC Power (VA)	4000	6000	7360	10000	10000	10000
Nominal AC Voltage (V)	220/230/240					
Nominal AC Voltage Range (V)	180~290					
Max. AC Current (A)	17.4	26.1	32.0	43.5	43.5	43.5
Displacement power factor	~1 (Adjustable from 0.8 leading to 0.8 lagging)					
AC Output @ Grid						
Nominal AC Power (W)	2000	3000	3680	4600	5000	6000 (Ireland 5750)
Max. Apparent AC Power (VA)	2200	3300	3680	4600	5500 (Belgium 5000)	6000 (Ireland 5750)
Nominal AC Voltage (V)	220/230/240					
Nominal AC Voltage Range (V)	180~290					
Nominal Grid Frequency (Hz)	50/60					

Nominal Grid Frequency Range (Hz)	45~55/55~65					
Nominal AC Current (A)	8.7	13.0	16.0	20.0	21.7	26.1 (Ireland 25)
Max. AC Current (A)	9.6	14.3	16.0	20.0	23.9	26.1 (Ireland 25)
THDi, Rated Power(%)	<3					
Power Factor	~1 (Adjustable from 0.8 leading to 0.8 lagging)					
EPS Output @ Off Grid						
Nominal EPS Power (W)	2000	3000	3680	5000	5000	6000
EPS Peak Power [VA]	1.1 x Pnom, 60 sec; 1.5 x Pnom, 1 sec					
Nominal EPS Voltage (V)	230					
Nominal EPS Frequency (Hz)	50 / 60					
Nominal EPS Current (A)	8.7	13.0	16.0	21.7	21.7	26.1
THDv(@Liner Load)(%)	< 3%					
Switch Time (typical value, ms)	internal switch <10, external switch <100					
Parallel Operation	2					
Battery Data						
Battery Type	Li-ion/Lead-acid					
Nominal Battery Voltage (V)	48					
Battery Voltage Range (V)	40~60					
Battery Capacity (Ah)	50~500					
Max. charge / discharge power (W)	2000	3000	3680	4600	5000	6000
Max.Charge/Discharge Current (A)	40	60	80	100	100	125
Charging Strategy for Li-Ion Battery	Self-adaption to BMS					
Communication with BMS	CAN					
Efficiency						
MPPT Efficiency(%)	99.9					
Max. Efficiency(%)	97.6		97.8			
Euro Efficiency(%)	96.8		97			

Max. Charge / Discharge Efficiency(@full load)	94.6	94.6			
Protection					
DC Reverse Polarity Protection	Integrated				
DC Surge Protection	Integrated				
AC Surge Protection	Integrated				
Output Over Current Protection	Integrated				
Output Short Circuit Protection	Integrated				
Output Over Voltage Protection	Integrated				
Anti-islanding Protection	Integrated				
Insulation Resistor Detection	Integrated				
Residual Current Detection	Integrated				
Ground Fault Monitoring	Integrated				
DC Switch	Integrated				
General Data					
Dimension (W*H*D mm)	414*625*145				
Weight (kg)	29	30	30	30	30
Mounting Method	Wall-mounting bracket				
Ingress Protection	IP65				
Cooling	Natural convection				
Operating Temperature Range (°C)	-25~+60°C (>45°C derating)				
Storage Environments (°C)	-30 ~ +70 °C				
Max. Operating Altitude (m)	2000				
Noise (dB)	<25				
Relative Humidity	0~100%,no condensation				
Cold standby Consumption (W)	<10				
Display	LED & APP				
Communication	RS485 for CT/Parallel/EV charger, CAN for BMS,USB for Wi-Fi				
Topology	High frequency isolation (for battery)				
Security Level	I				
Over voltage category	III(MAINS),II(PV, BATTERY)				
Pollution Degree	III				

Notes: (1) Backup output power depends on the battery.

(2) Specifications are subject to change without further notice.

11. Disclaimer

The Hyper series inverters are transported, used and operated under limited condition, such as environmental, electrical etc. **LIVOLTEK** shall not be liable to provide the service, technical support or compensation under conditions listed below, including but not limited to:

- Inverter is damaged or broken by force majeure (such as earthquake, flooding, thunderstorm, lighting, fire hazard, volcanic eruption etc.).
- Inverter's warranty is expired and doesn't buy extended warranty.
- Can't provide the inverter's SN, warranty card or invoice.
- Inverter is damaged by man-made cause.
- Inverter is used or operated against any items in local policy.
- Inverter's installation, configuration, commissioning doesn't follow the requirements mentioned in this manual.
- Inverter is installed, refitted or operated in improper ways mentioned in this manual without authority from LIVOLTEK.
- Inverter is installed, operated under improper environment or electrical condition mentioned in this manual without authority from LIVOLTEK.
- Inverter is changed, updated or disassembled on hardware or software without authority from LIVOLTEK.
- Obtain the communication protocol from other illegal channels.
- Build monitoring, control system without authority from LIVOLTEK.
- LIVOLTEK will keep right to explain all the contents in this user manual.

Warranty Card Registration

LIVOLTEK

Dear customer, thank you for choosing LIVOLTEK product.
For registering product warranty, please prepare everything ready and register on
<https://www.livoltek.com/registration.html>.

Product Information	
Product Type	
Product S/N	
Installation date	
Installation Company	
Personal Information	
Your name	
Your contact number	
Your Email address	
Your home address	

*Warranties should be registered within 36 months of installation, however it is recommended that they are registered no more than 6 weeks following the successful installation and commissioning of the Product where possible, thanks for your cooperation.



Contacts

Hangzhou LIVOLTEK Power Co., Ltd

Address: 1418-35 Moganshan Road, Hangzhou, 310011, China

Tel: +86-571-28330320

Fax: +86-571-28020357

Email: info@livotek.com

Web: www.livotek.com